



# CITY



60186





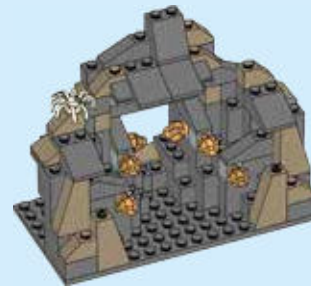
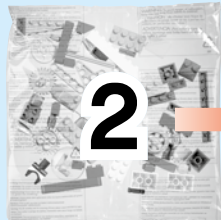
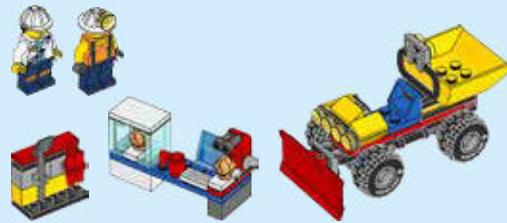

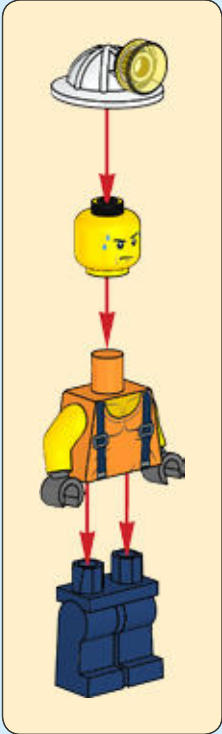
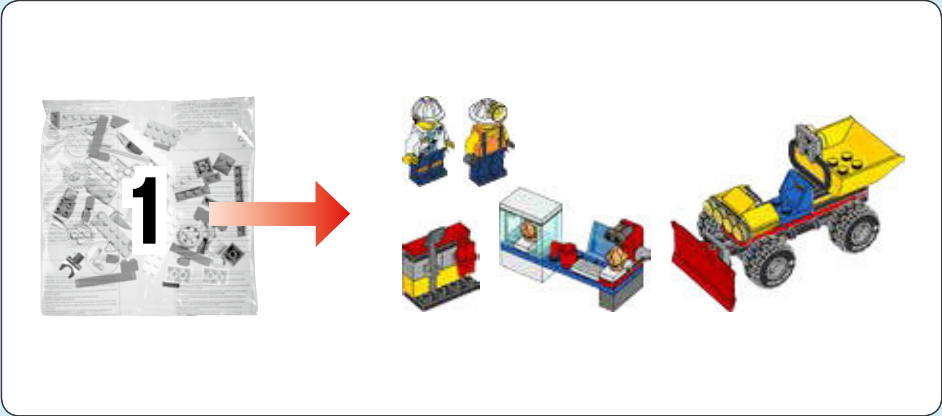

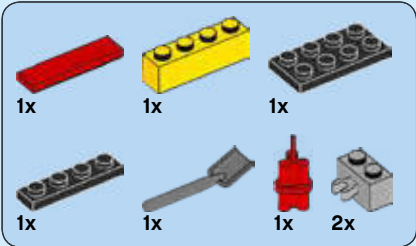

1

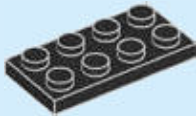

2

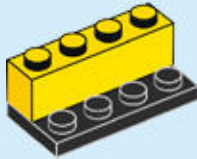

3

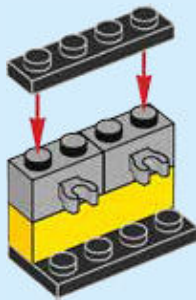

4

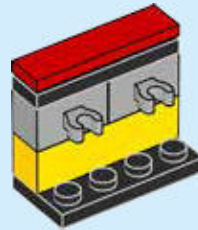

5

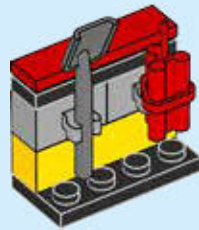

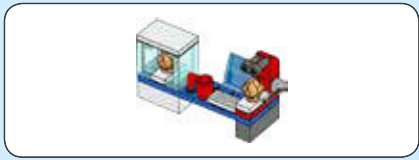

1x

**1**



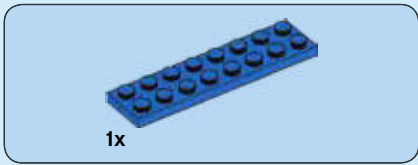

**2**

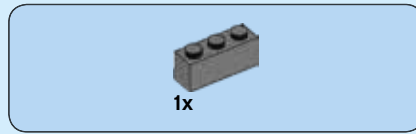
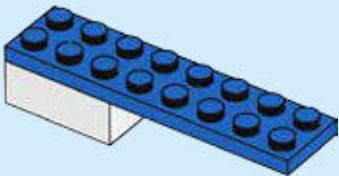

**3**

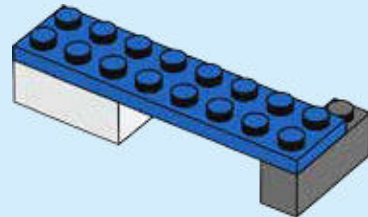



1x

4

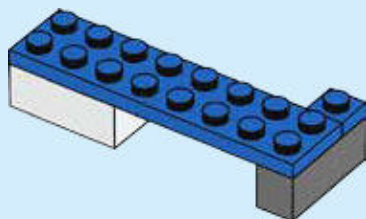





1x



1x

5

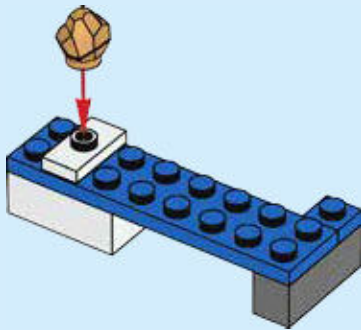

2x

6

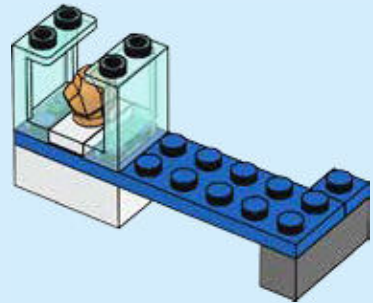



1x

7

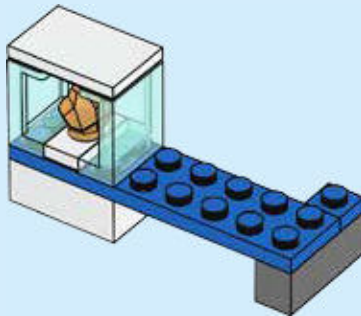

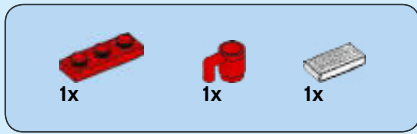

8

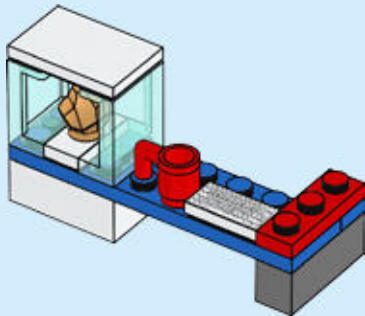

9

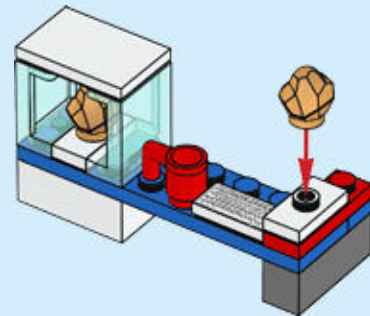

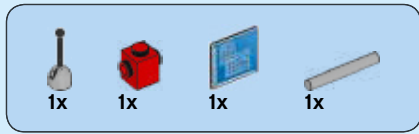

10

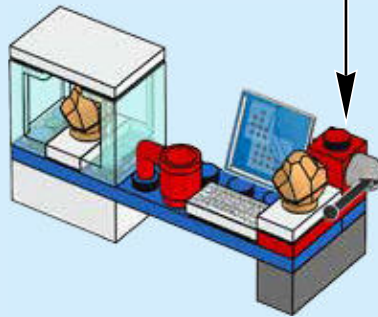
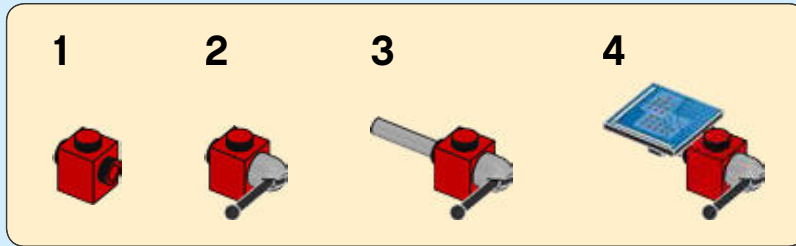



1x

11

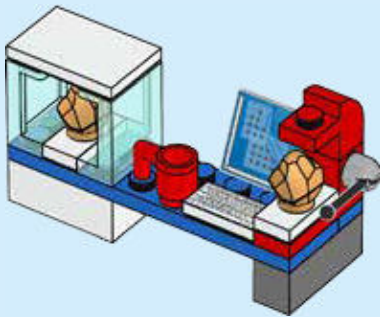

1x

12

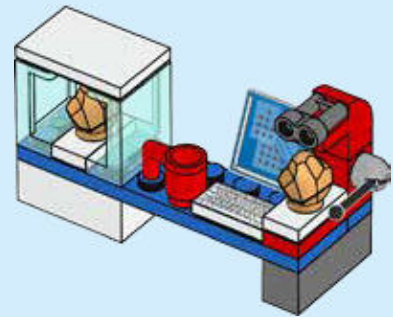

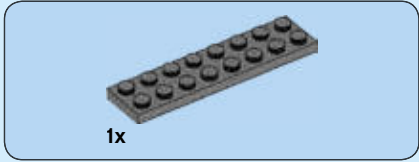
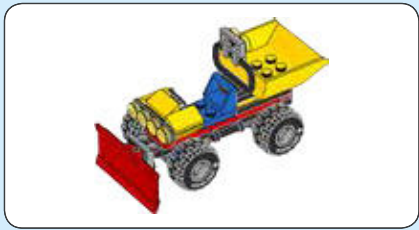

1

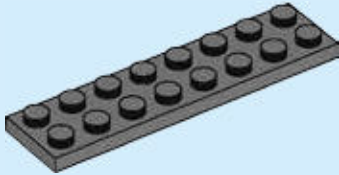



2

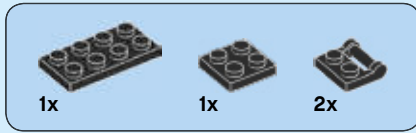
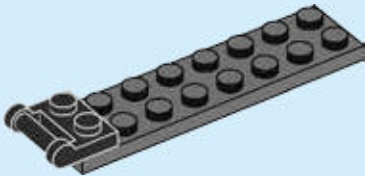

3

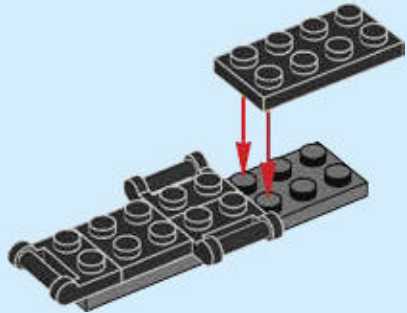

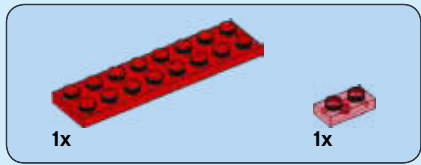

4

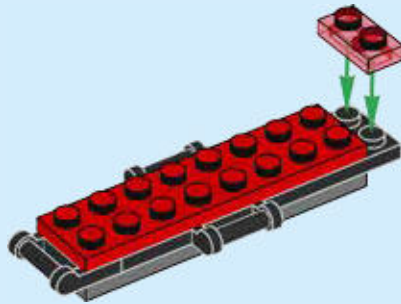



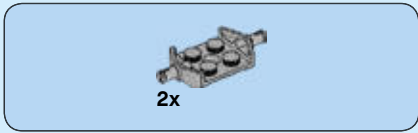

5

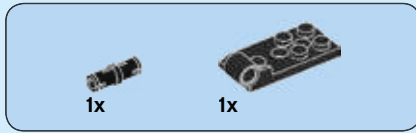
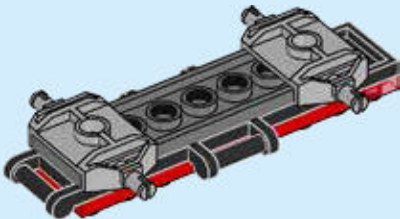

6

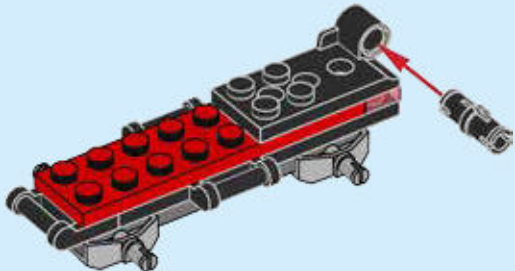
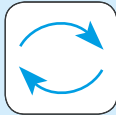



7

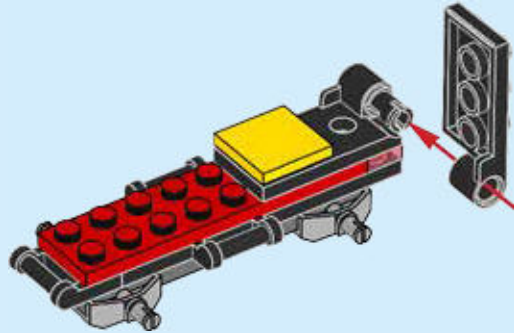



1x

8

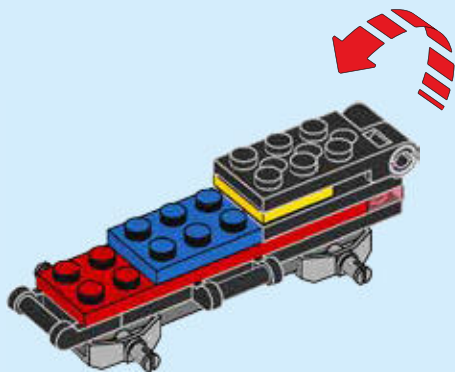

1x

9

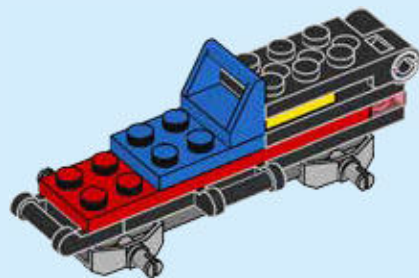





1x

11

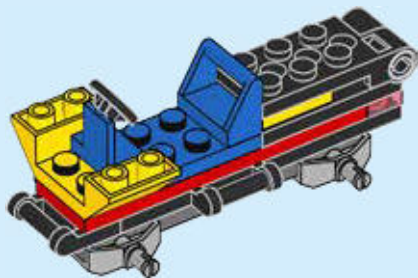

1x



1x

12

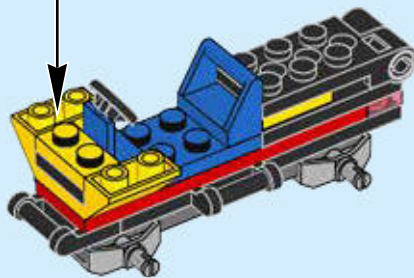
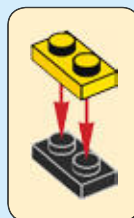



1x

13

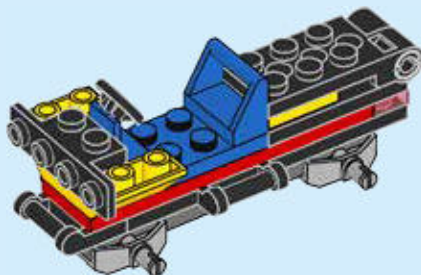



3x

14

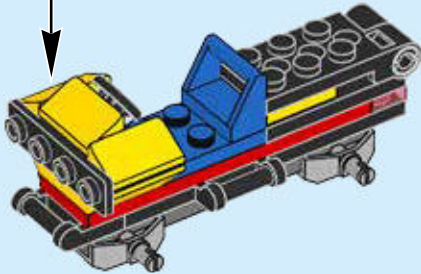
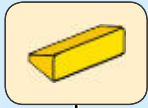

4x

15

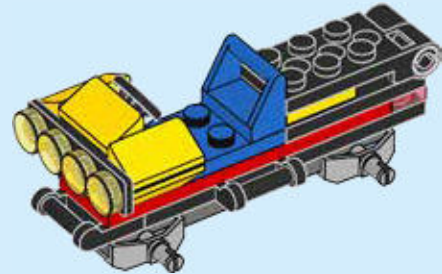



1x

16

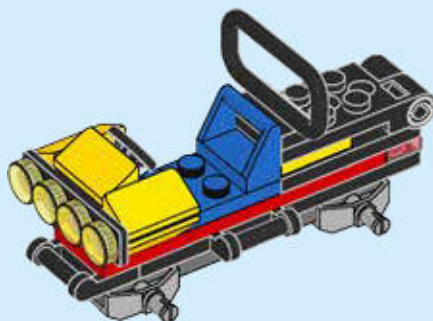



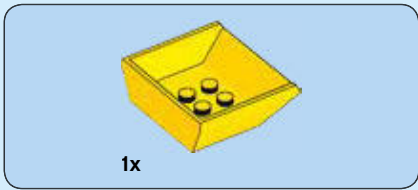

17

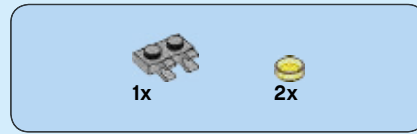
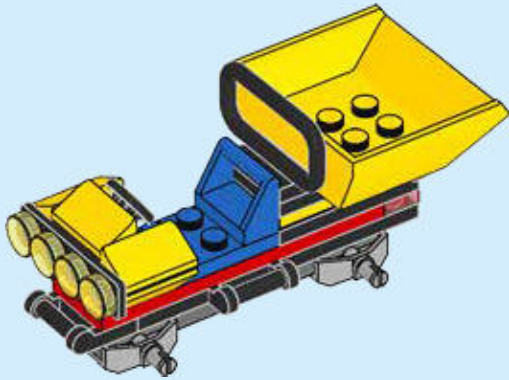

18

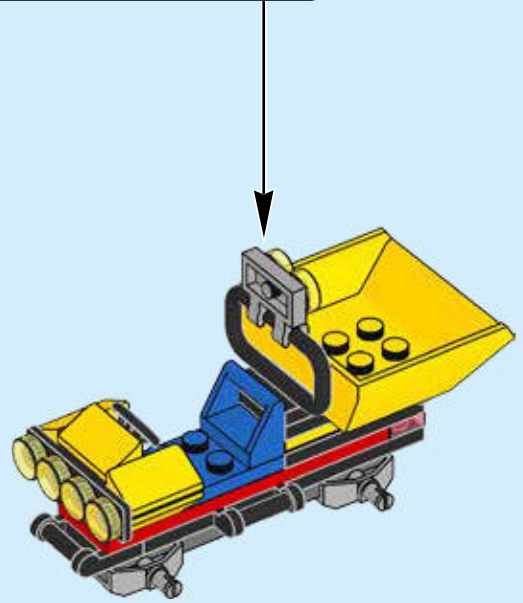
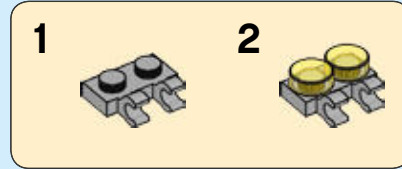

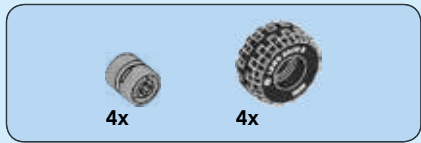

19

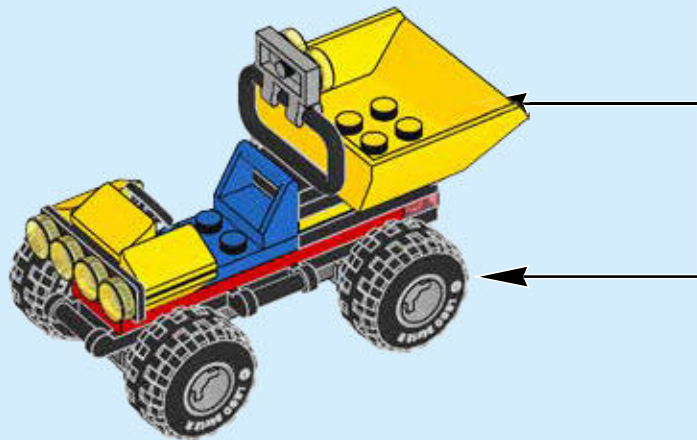
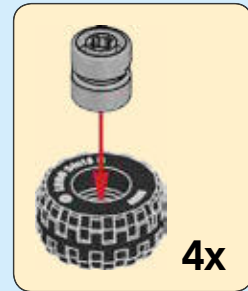

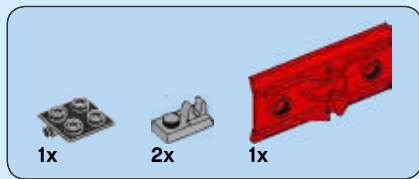

20

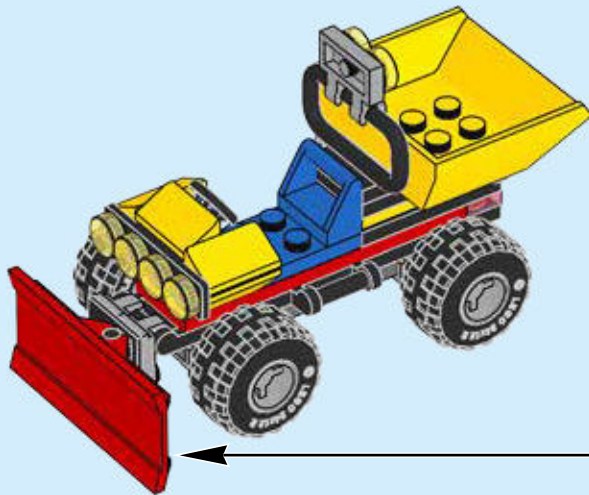
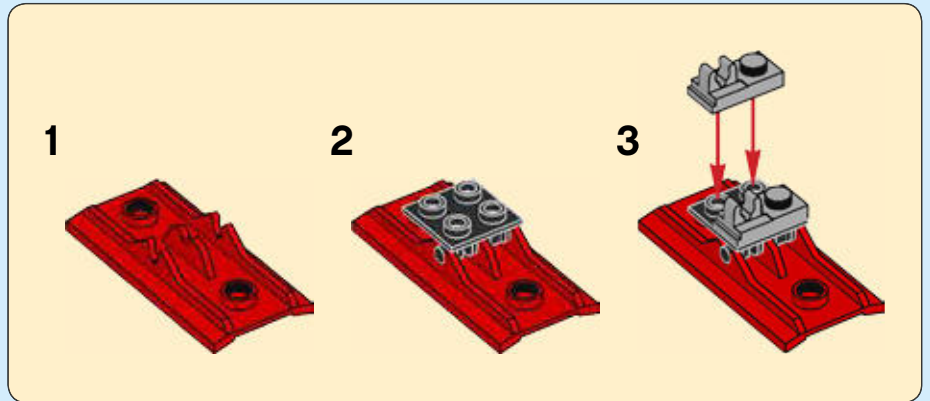

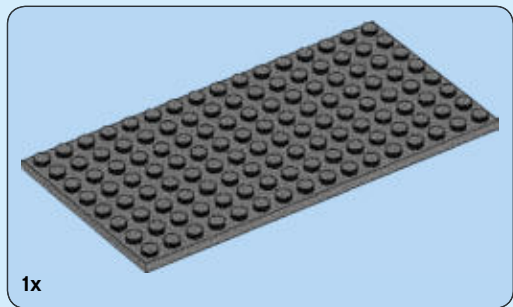
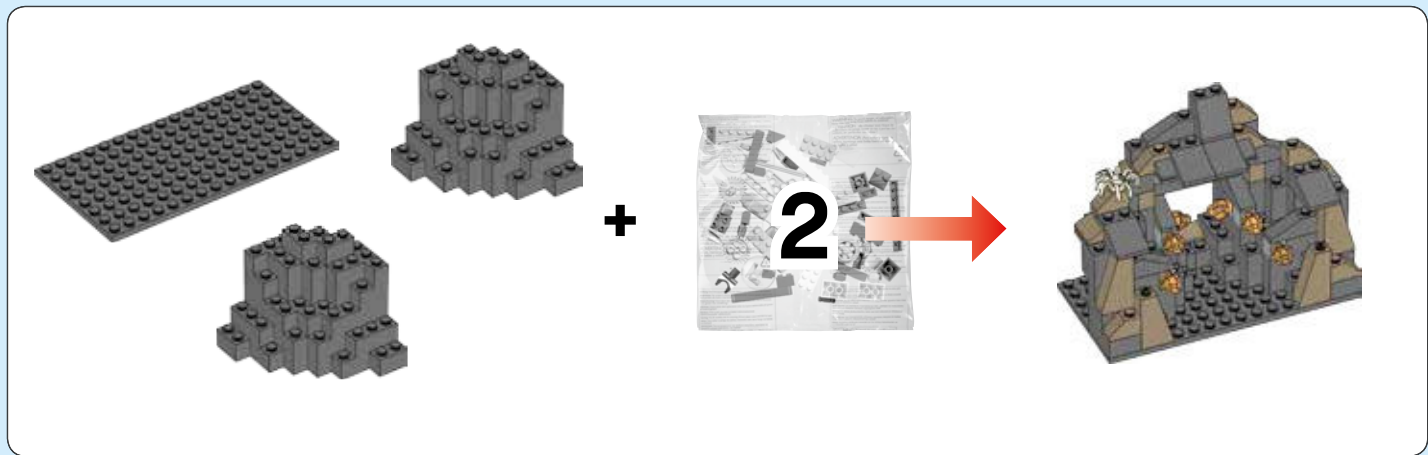

**1**

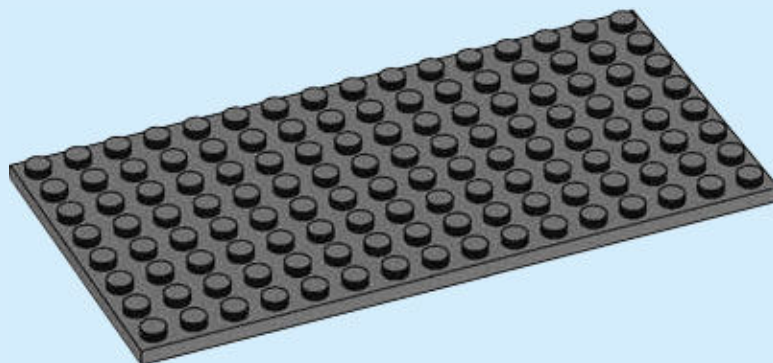

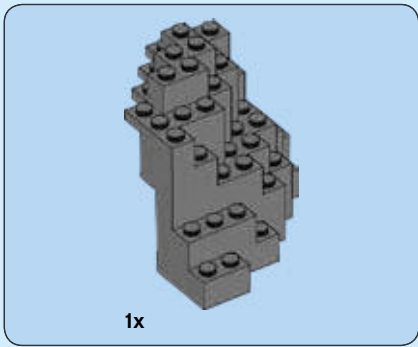

2

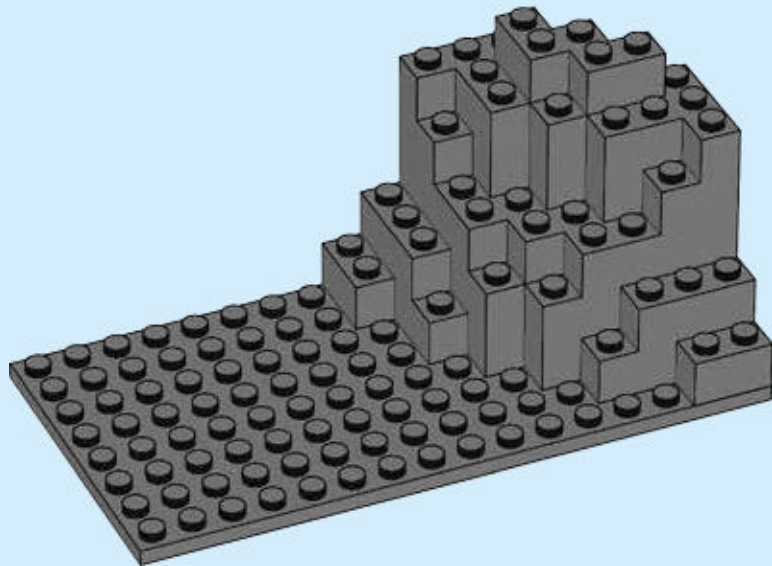

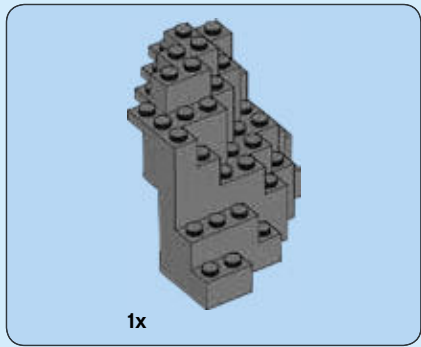

3

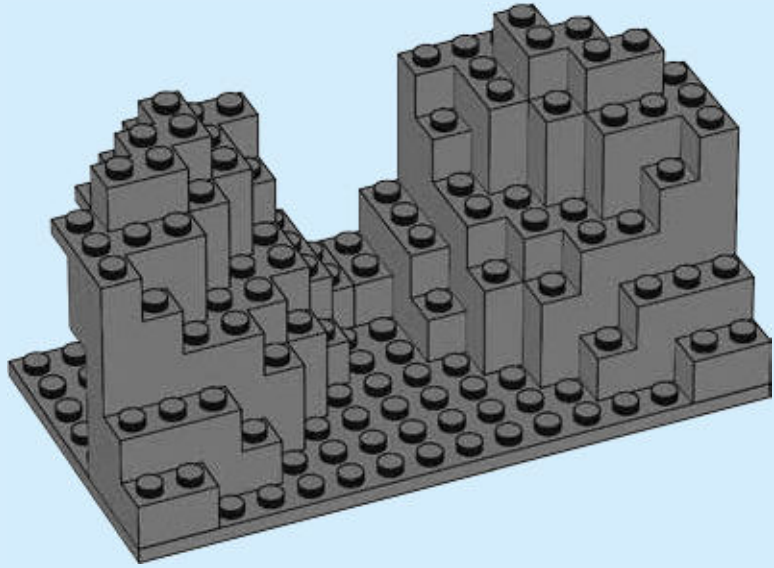



4

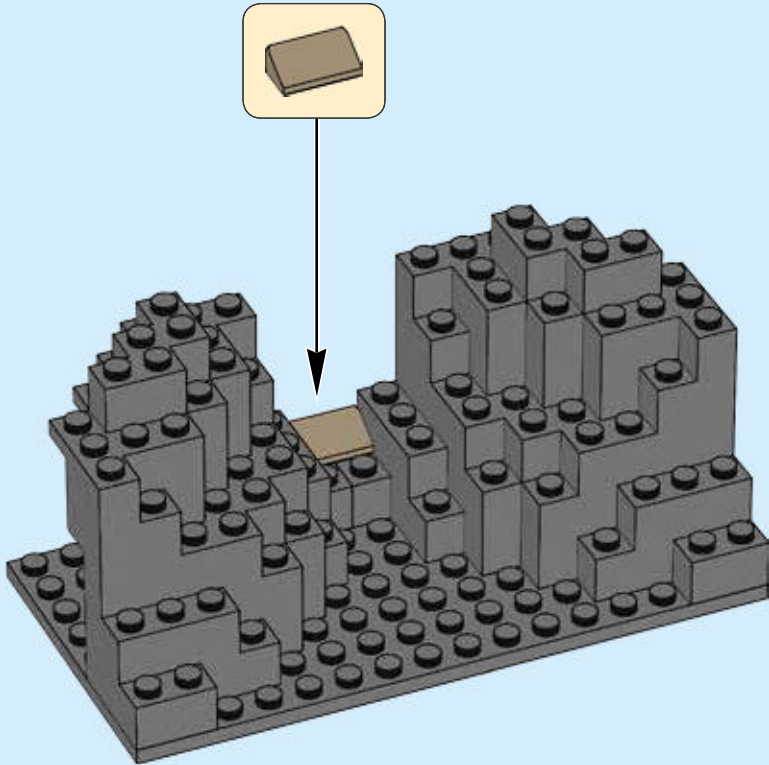



6x



6x

5

1



2



6x

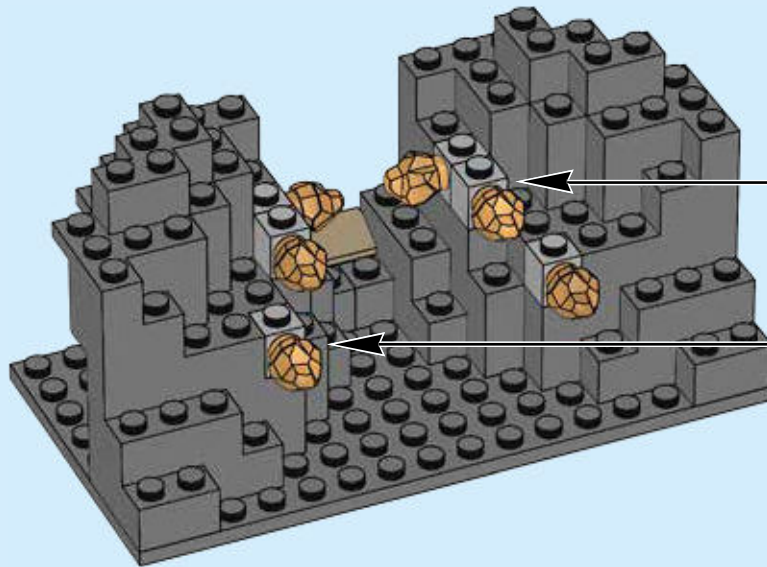





4x

6

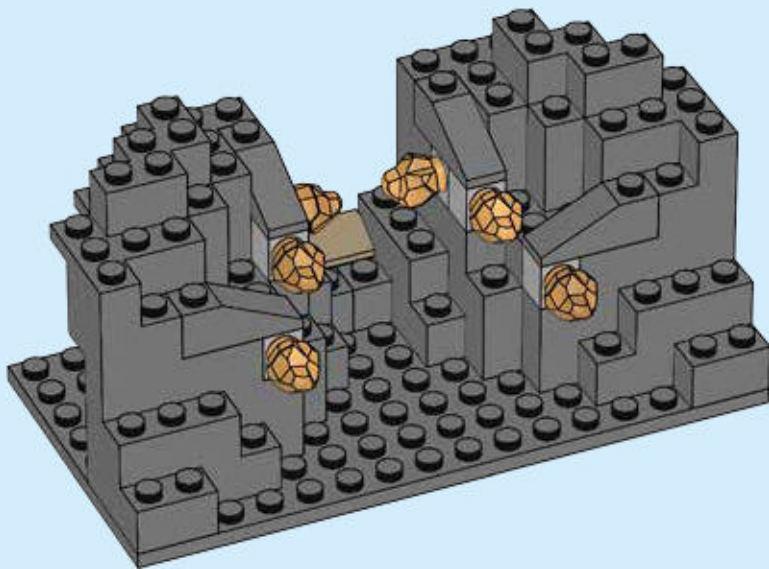

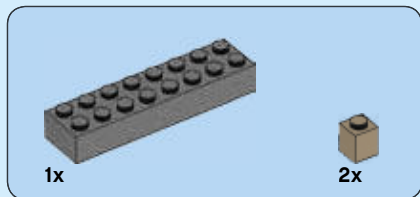

7

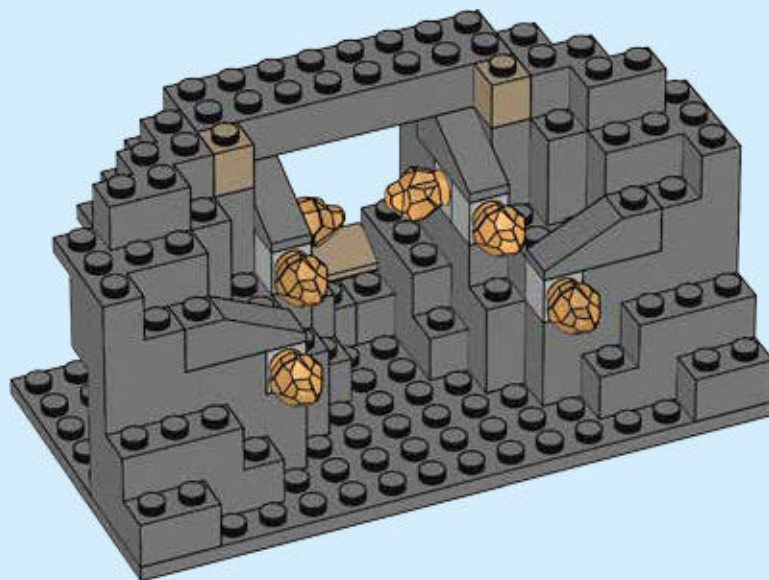

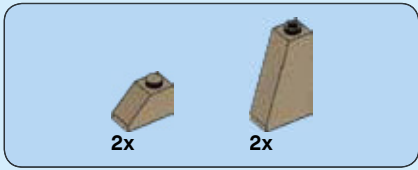

8

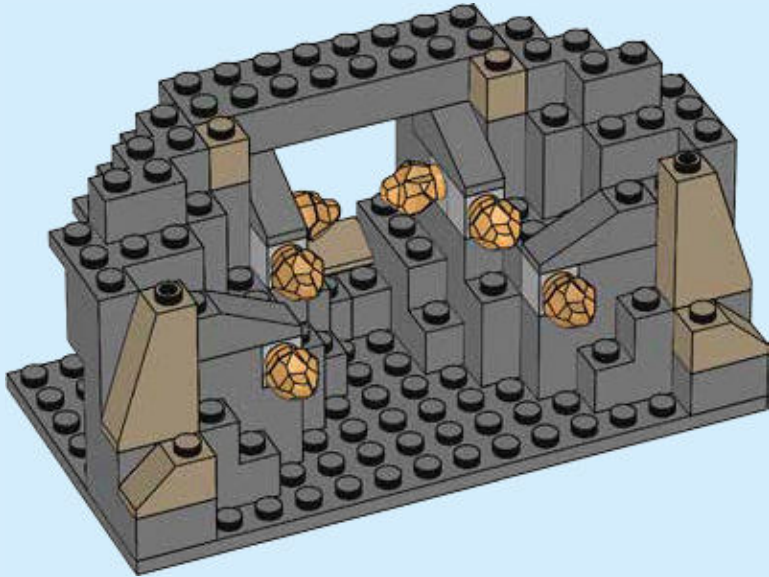



9

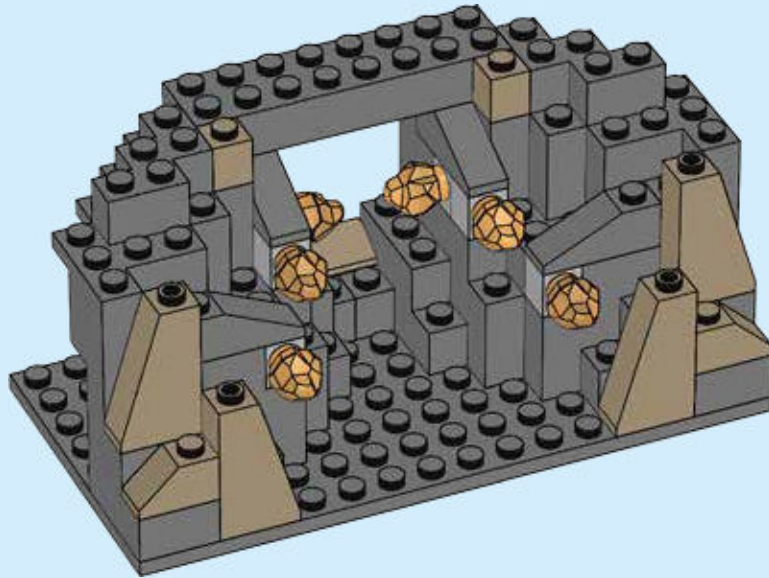



2x

10

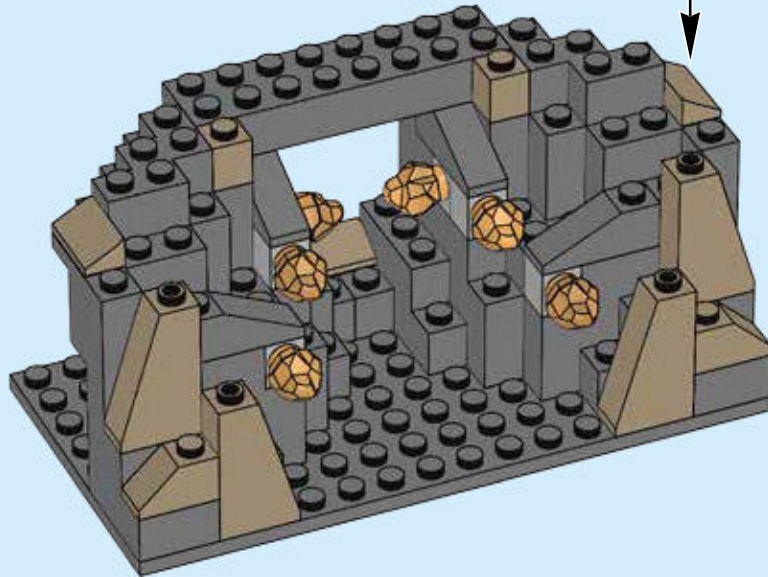
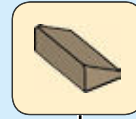



2x

11

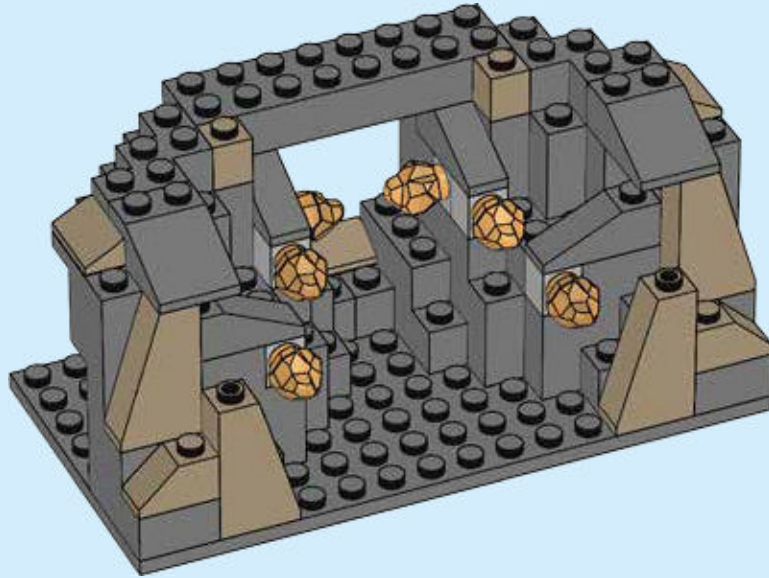

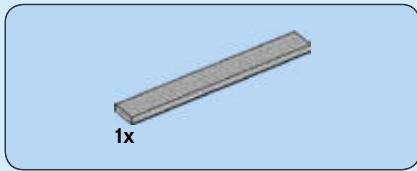

12

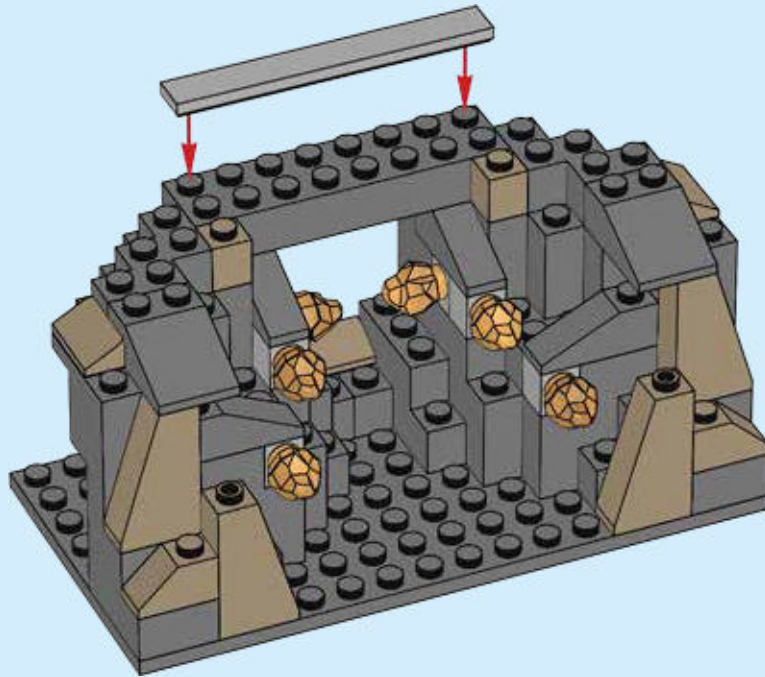



2x

13

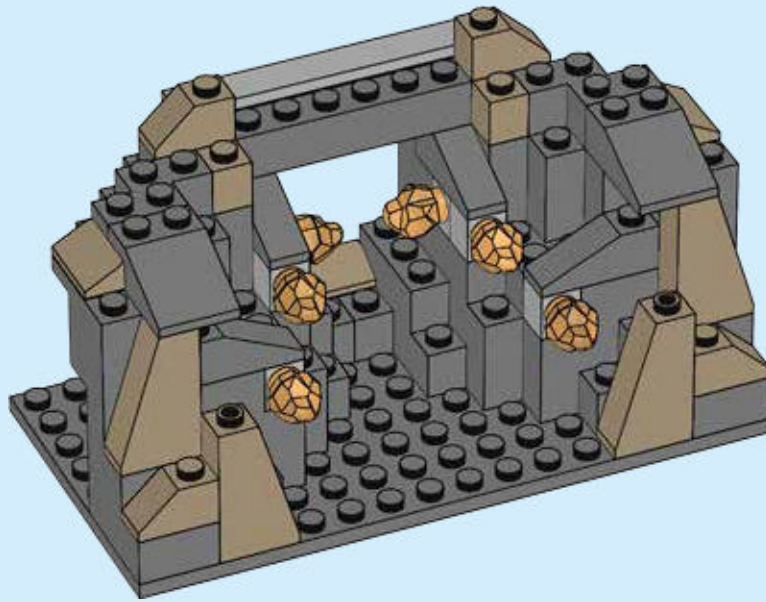





2x

14

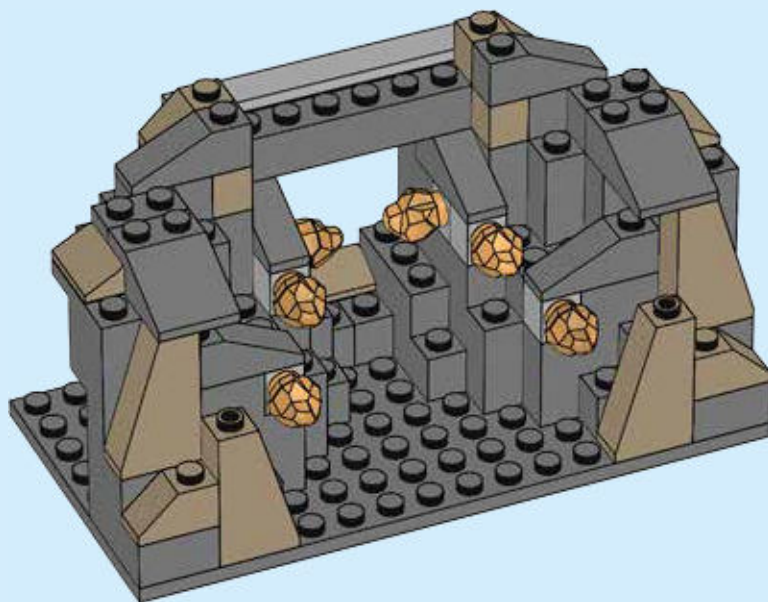



2x

15

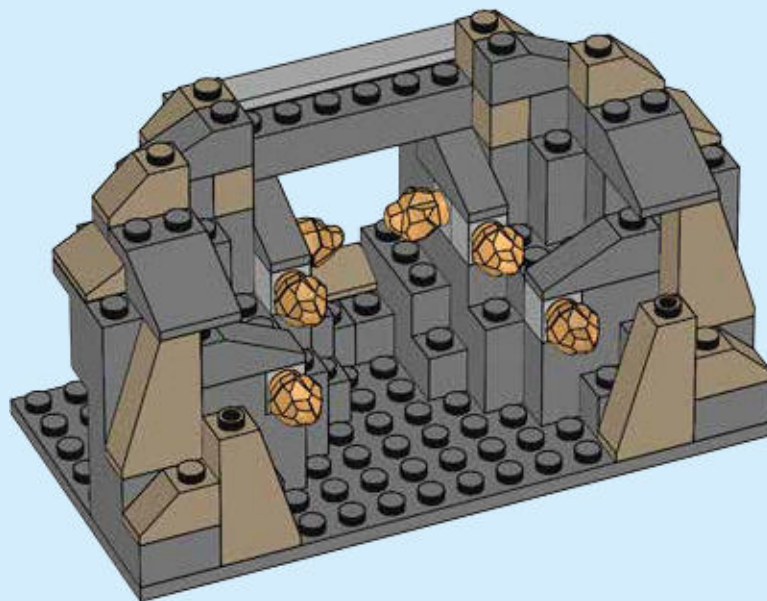

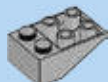

3x

16

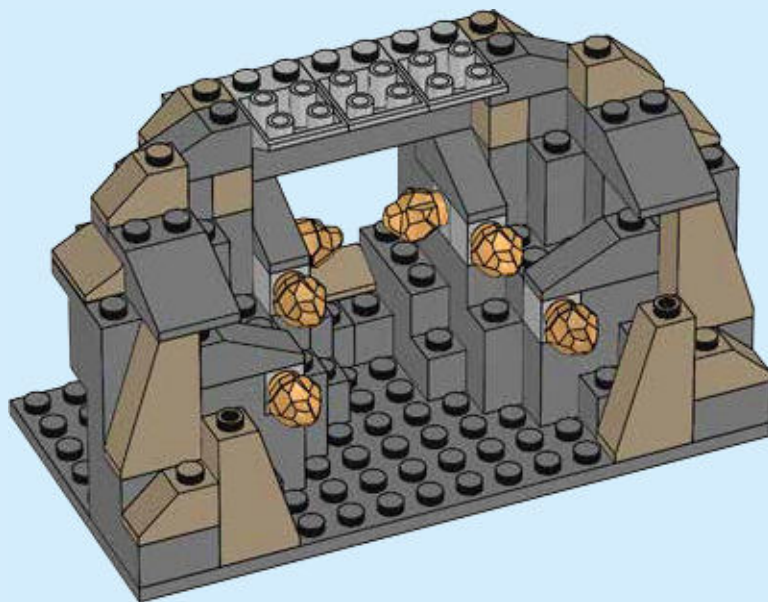

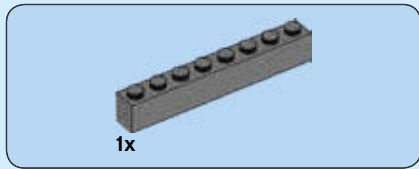

17

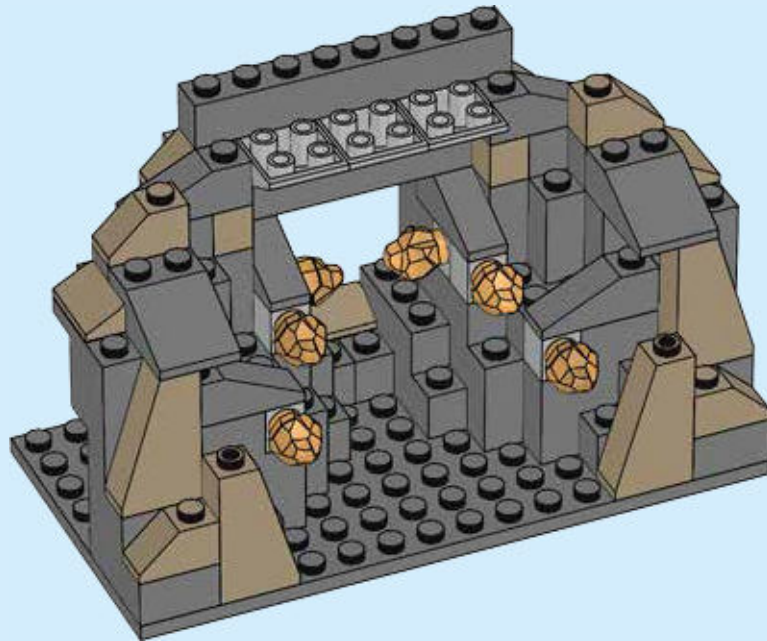





2x

19

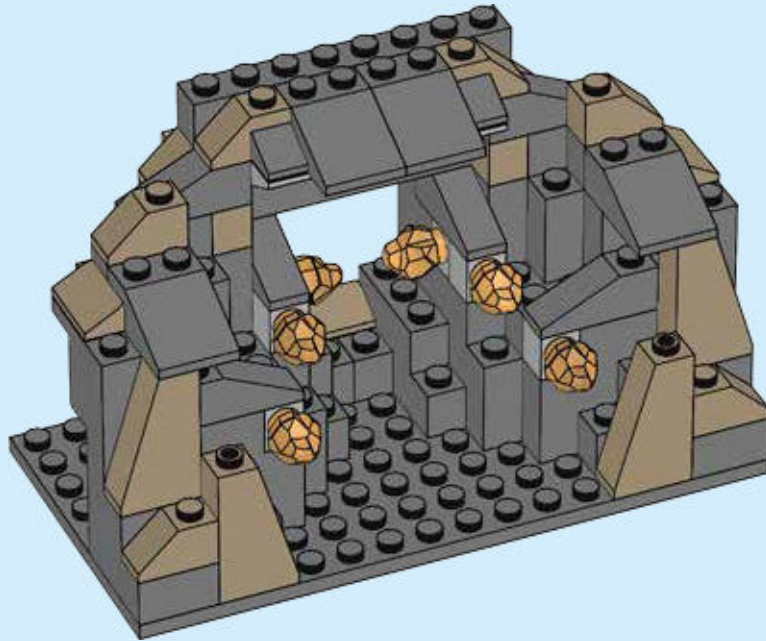



1x

20

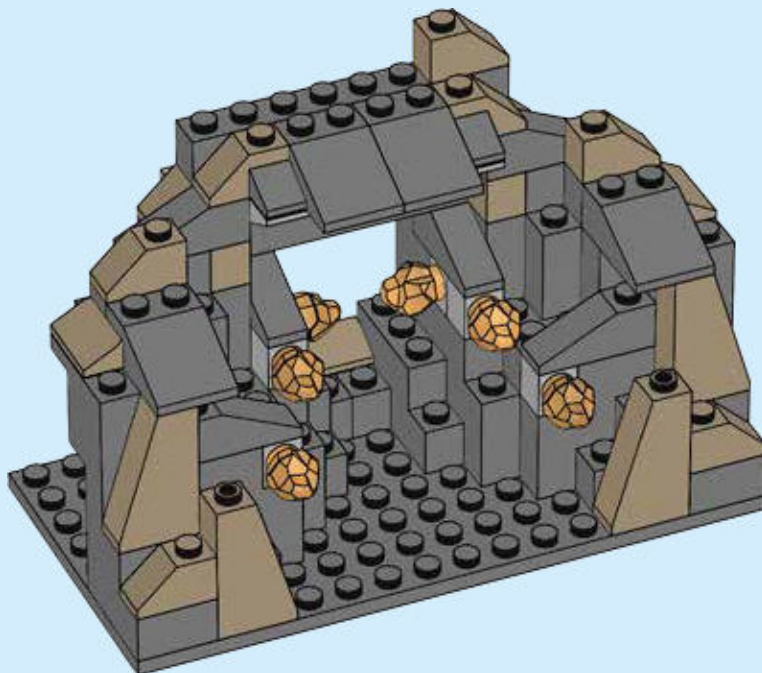

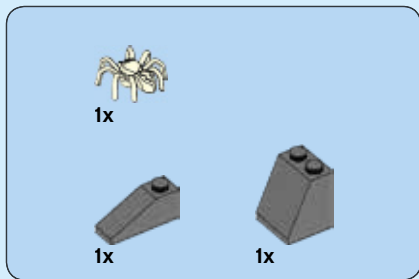

21

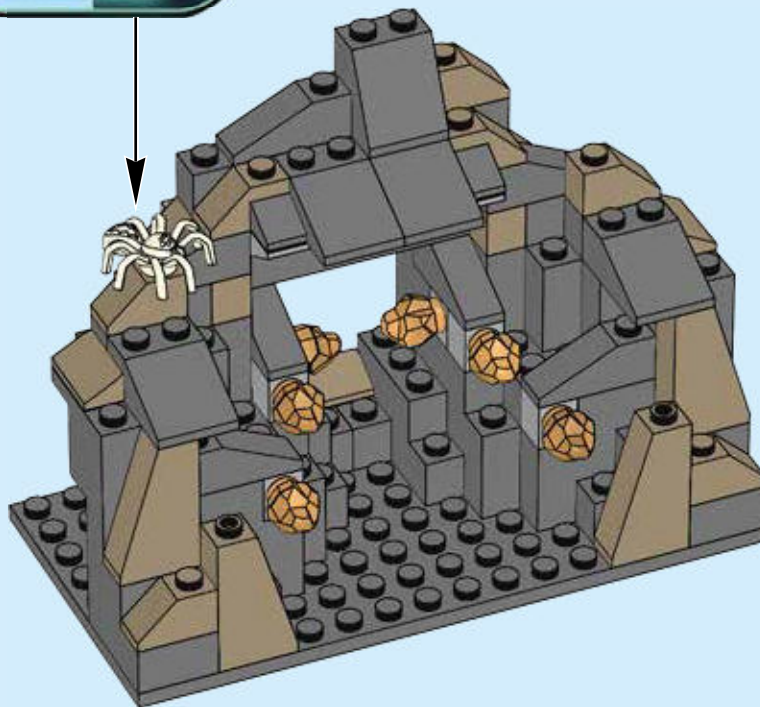





# CITY



60186



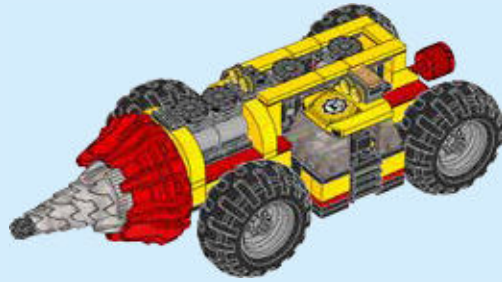
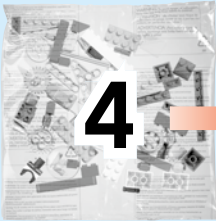
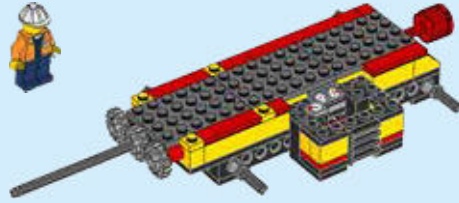
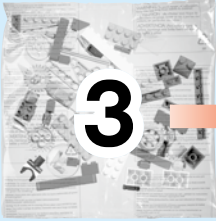

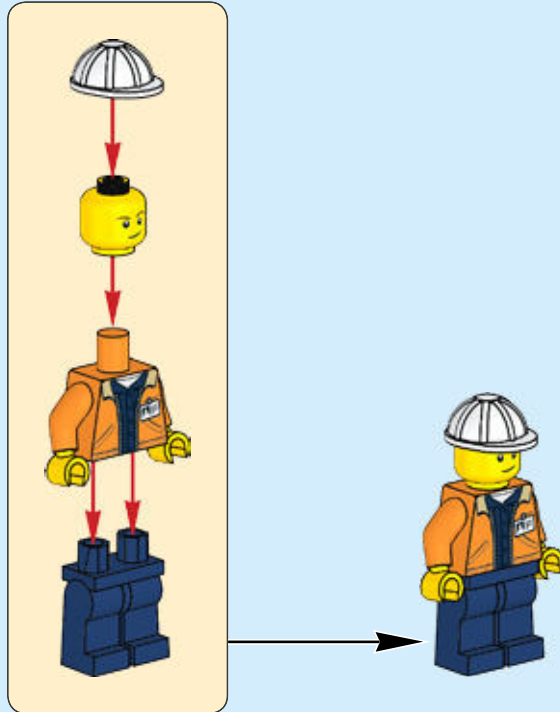
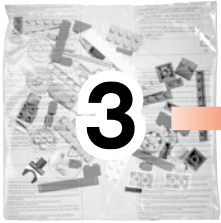

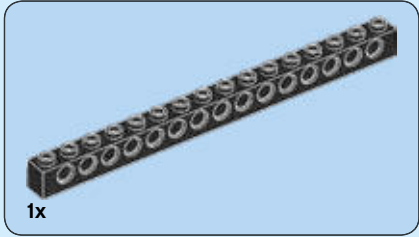
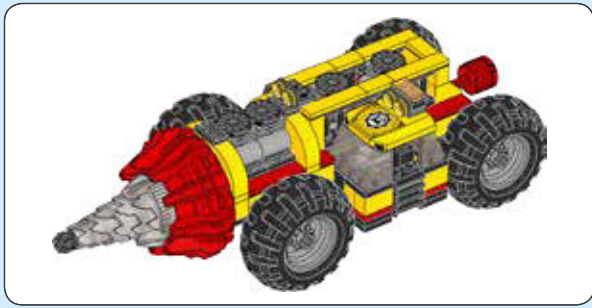

1

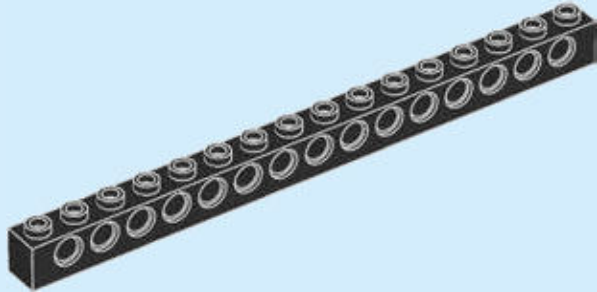

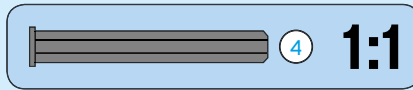
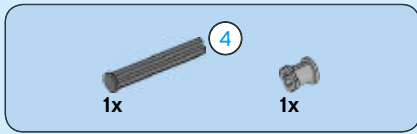

2

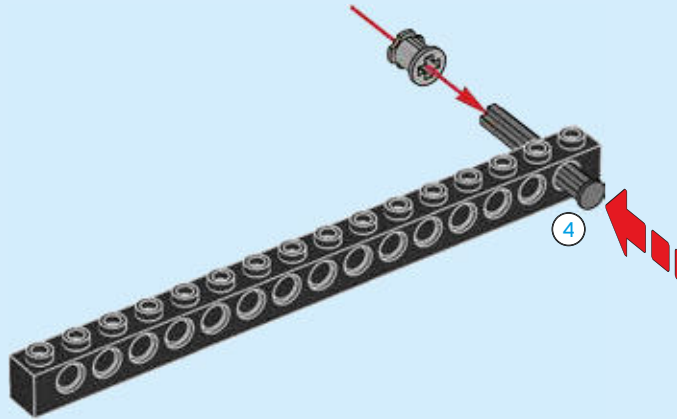

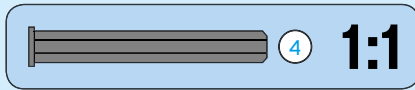
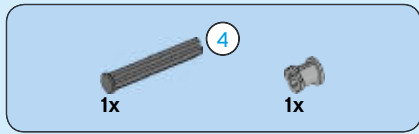

3

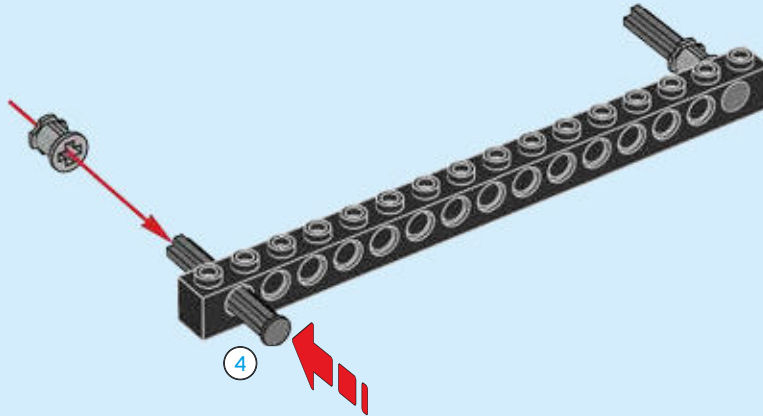

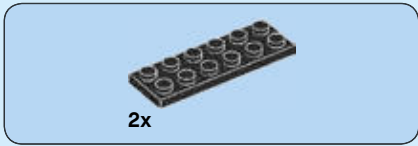

4

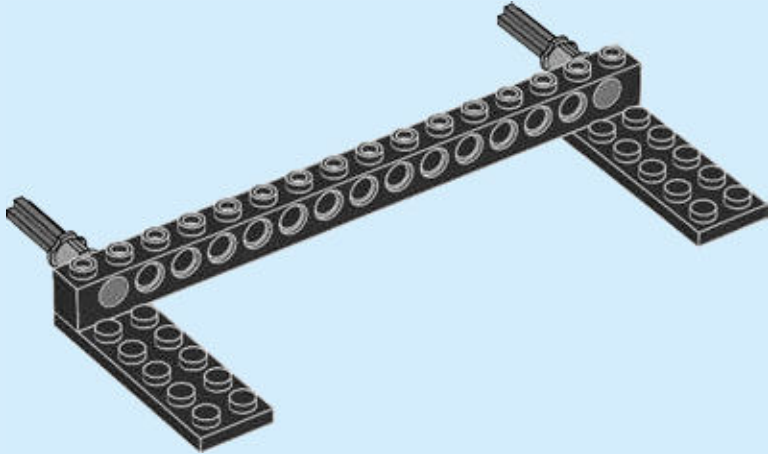



2x

5

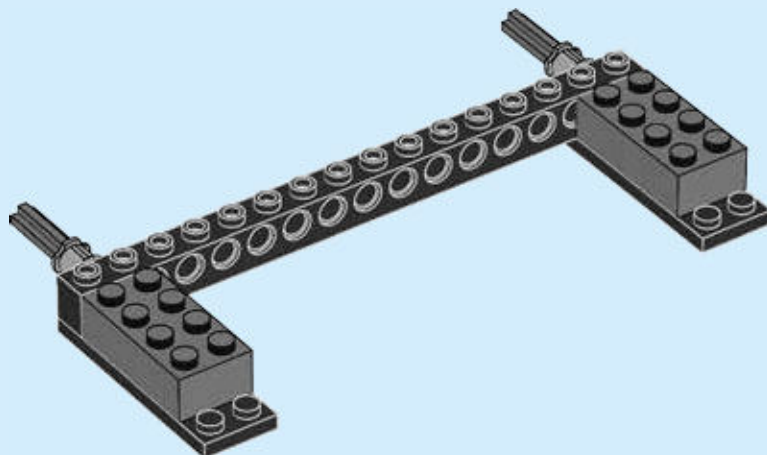



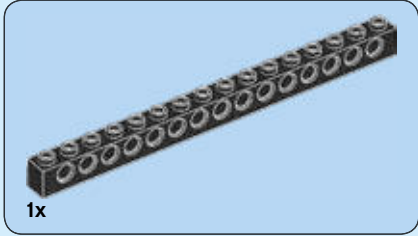
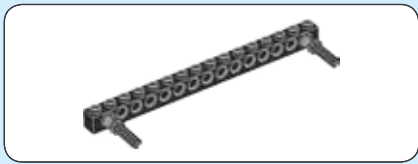

6

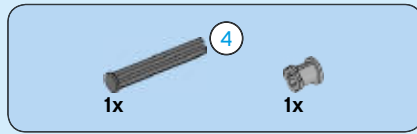
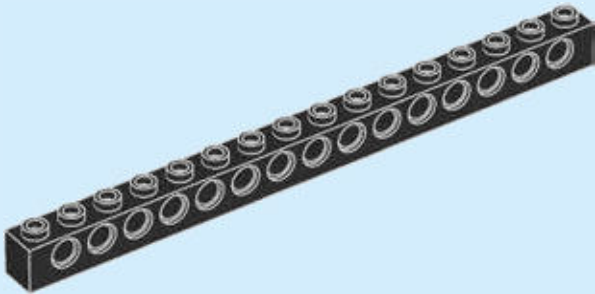

7

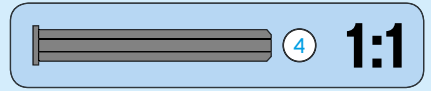
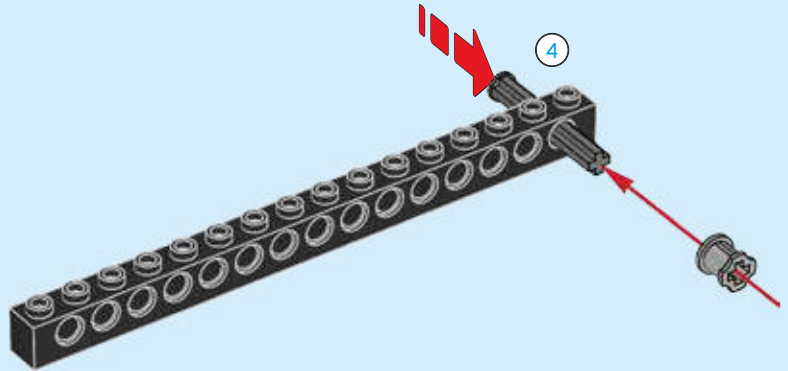

9

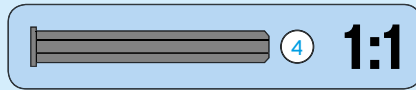
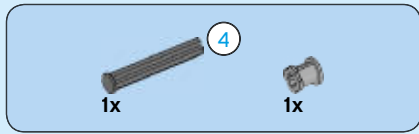

8

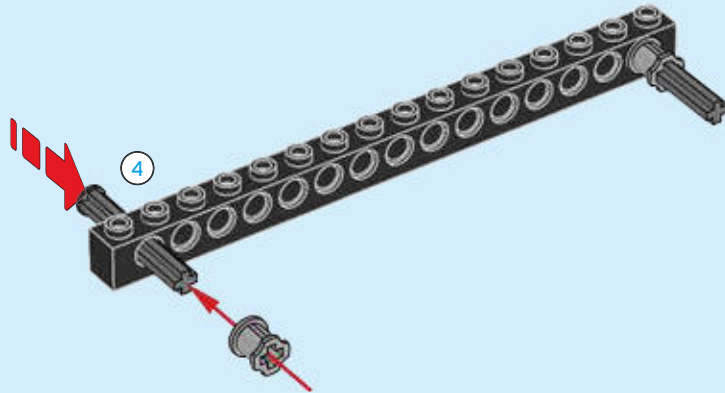

9

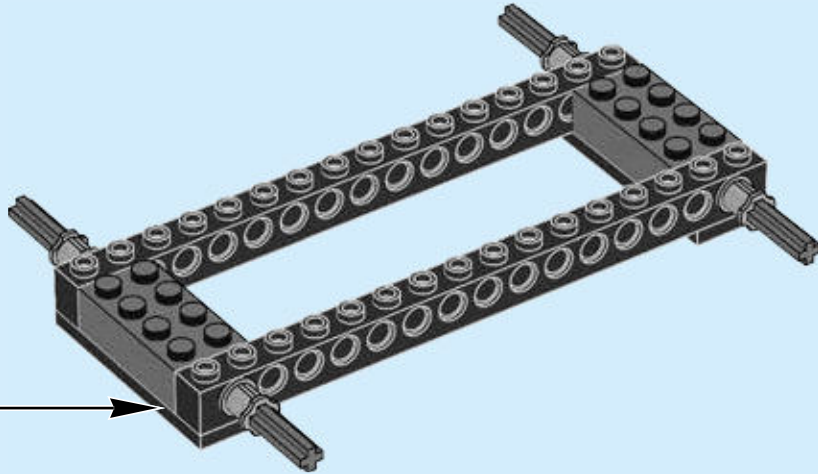

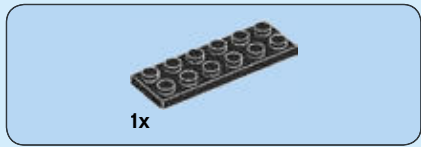

10

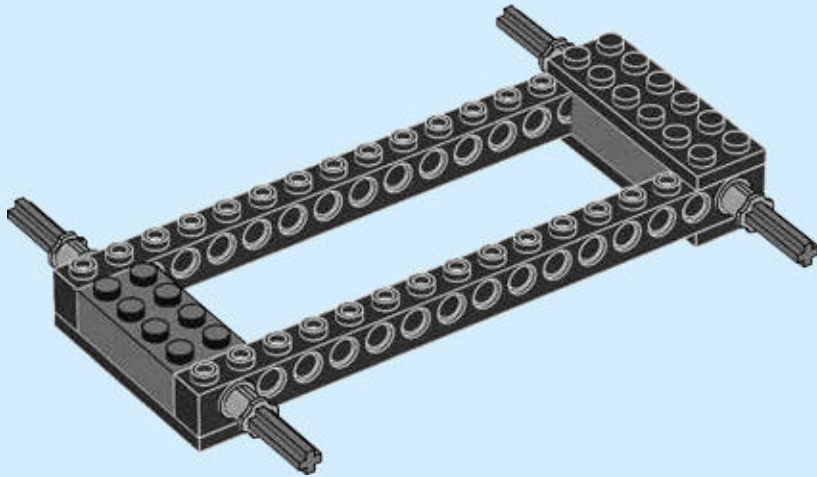



1x

11

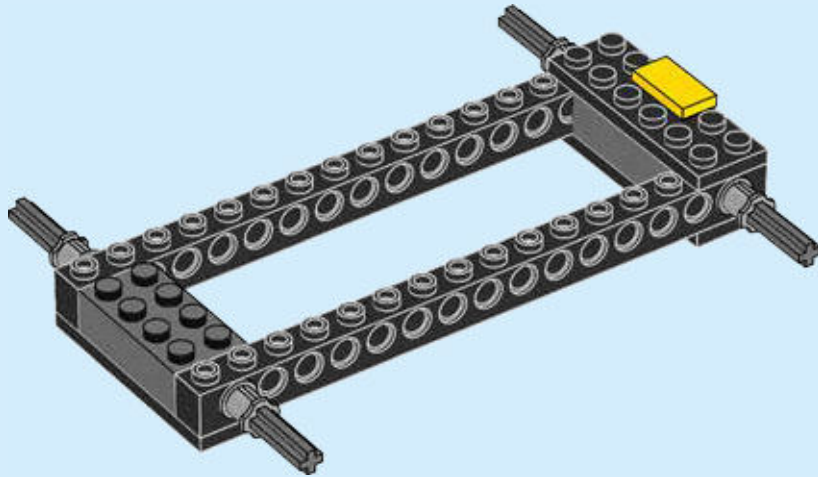

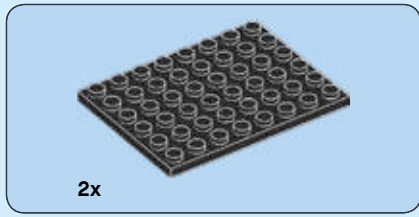

12

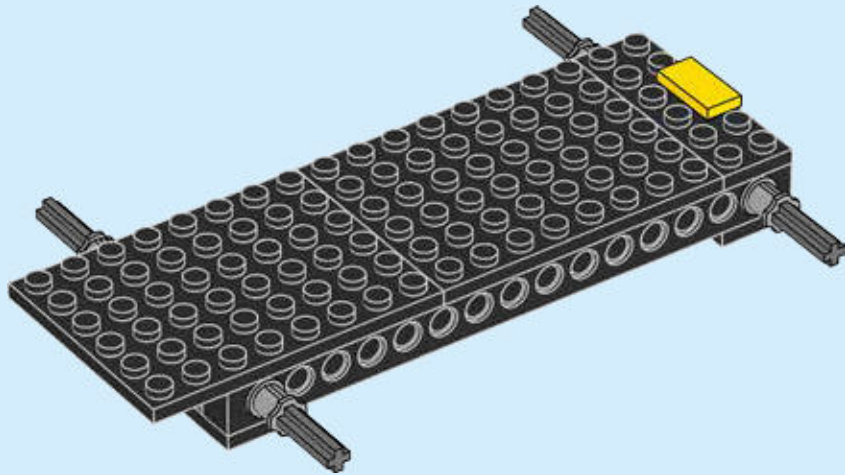



1x



1x

13

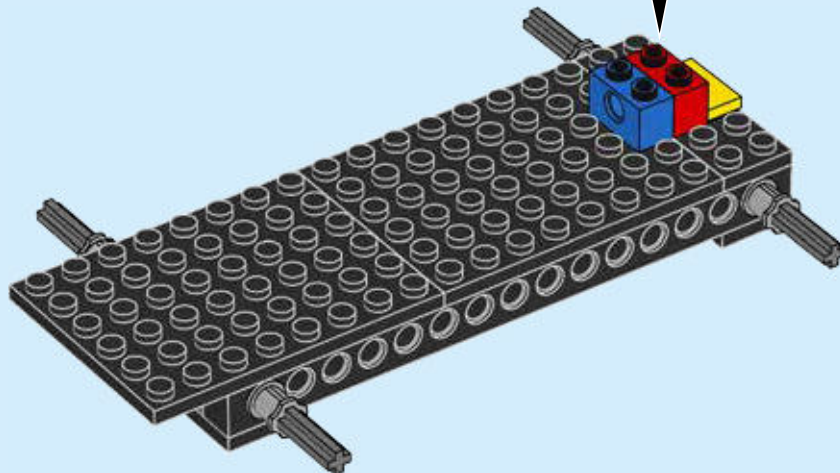
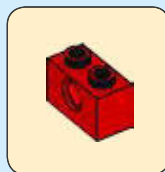



2x

14

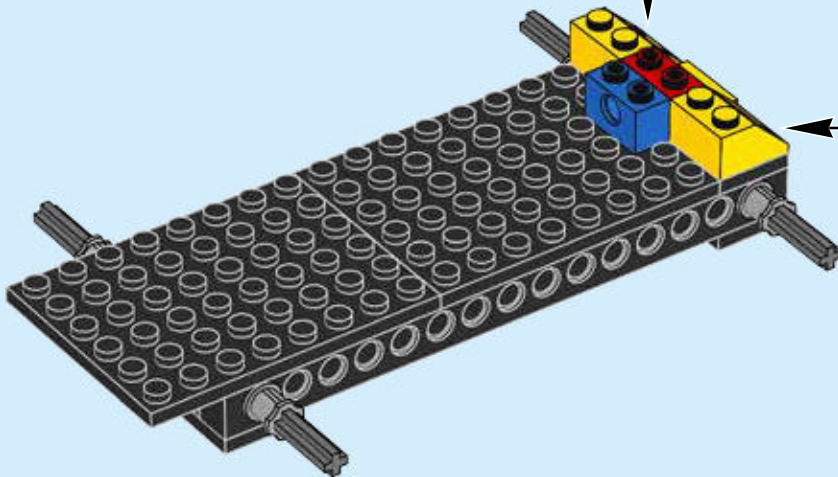
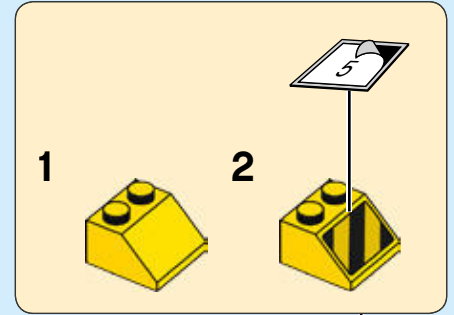
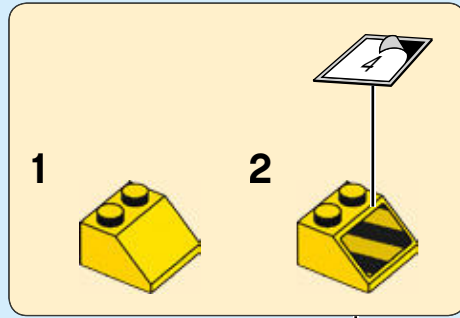





2x

15

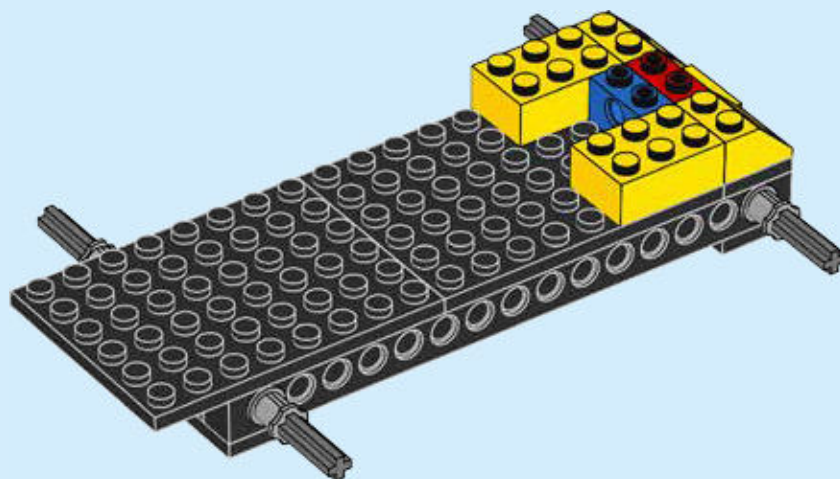

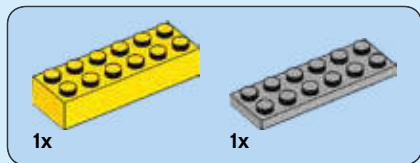

16

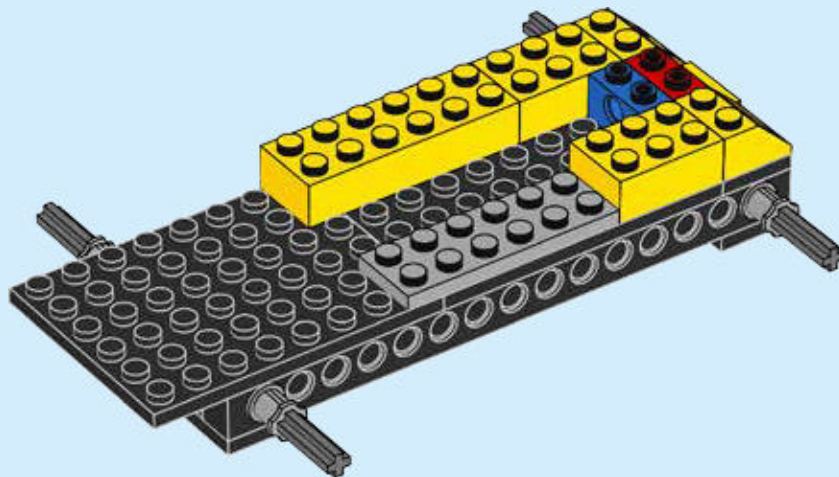

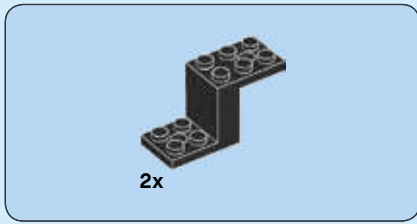

17

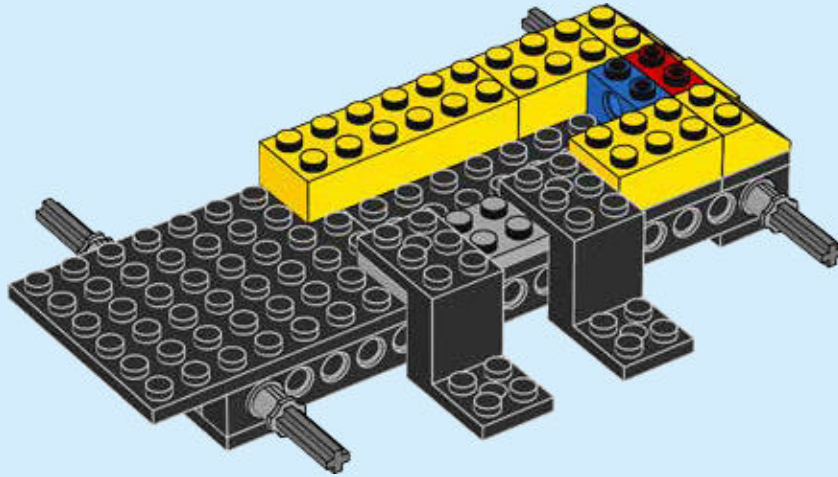

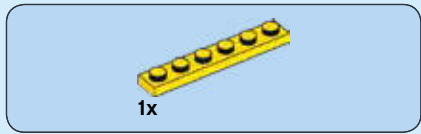

18

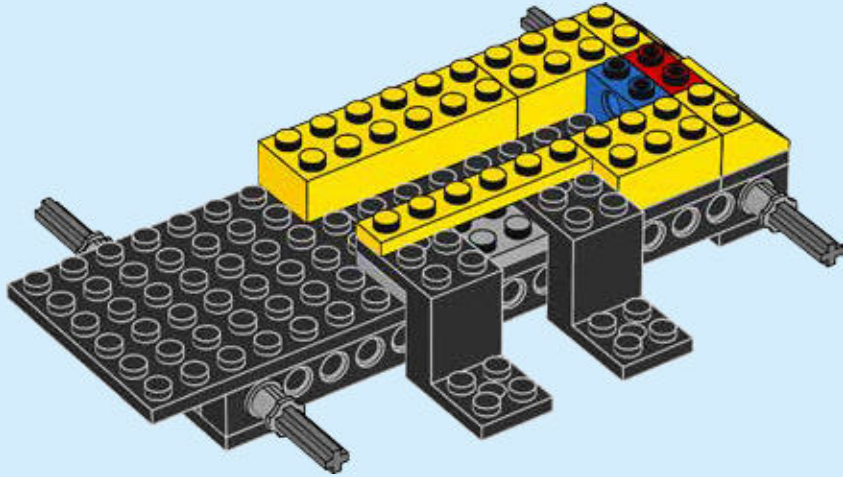

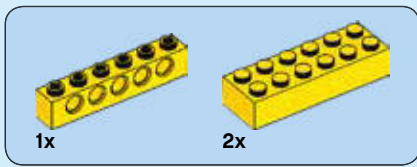

19

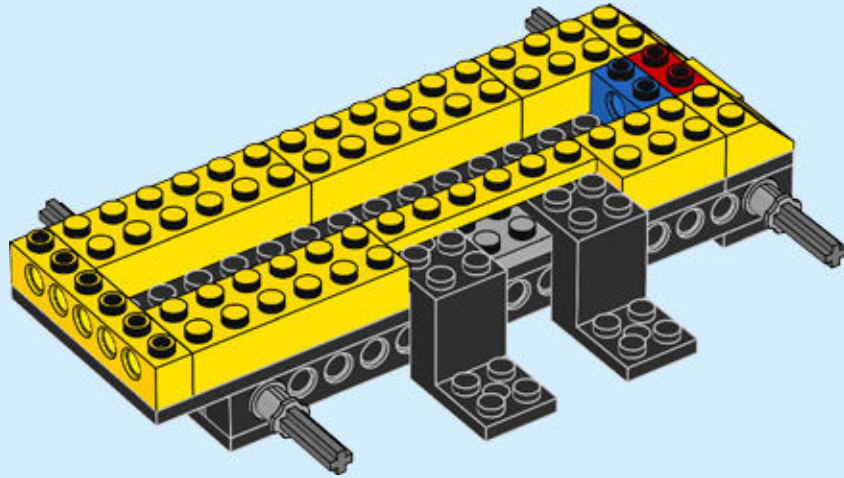



2x

20

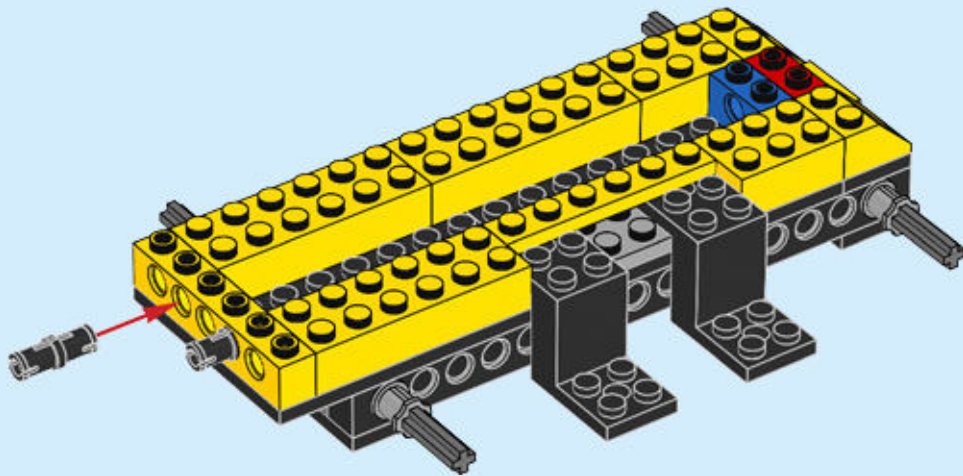

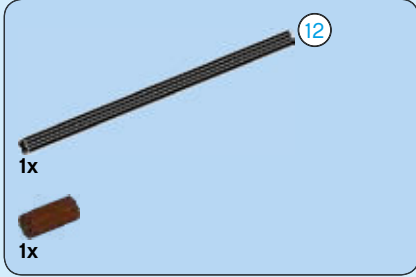
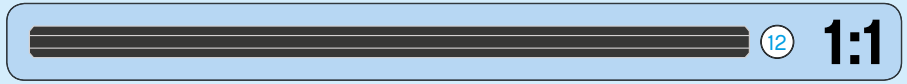
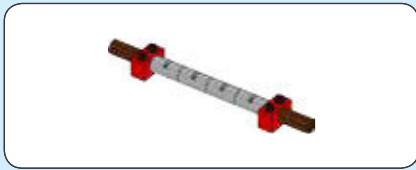

21





1x

22

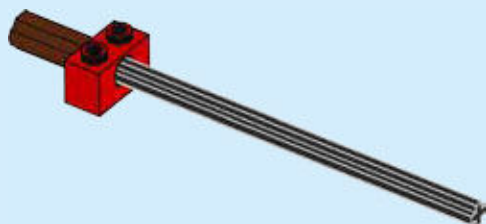





4x

23



1x

24





1x

25

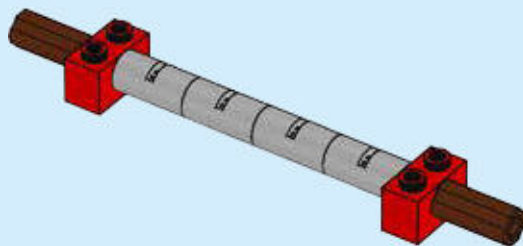

26

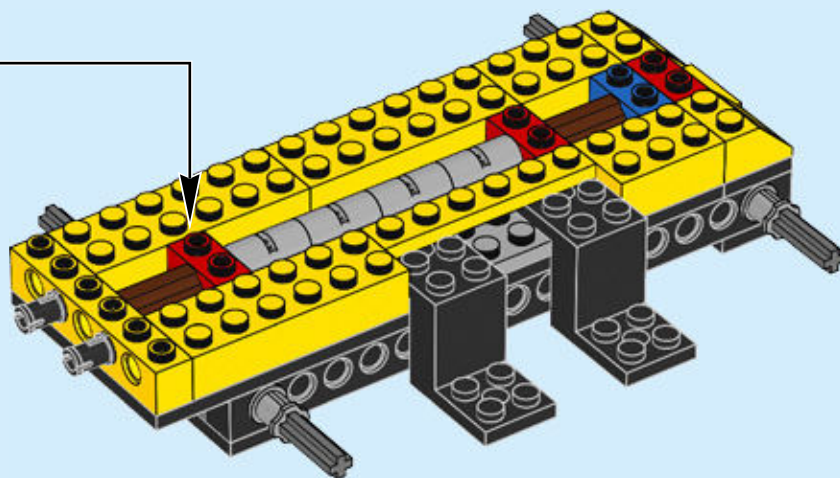

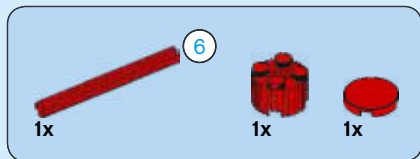

27

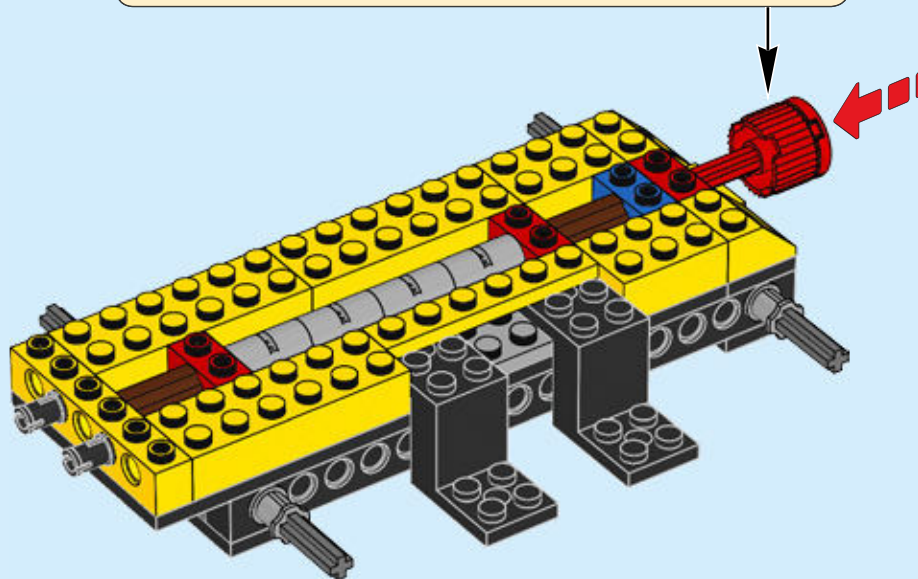
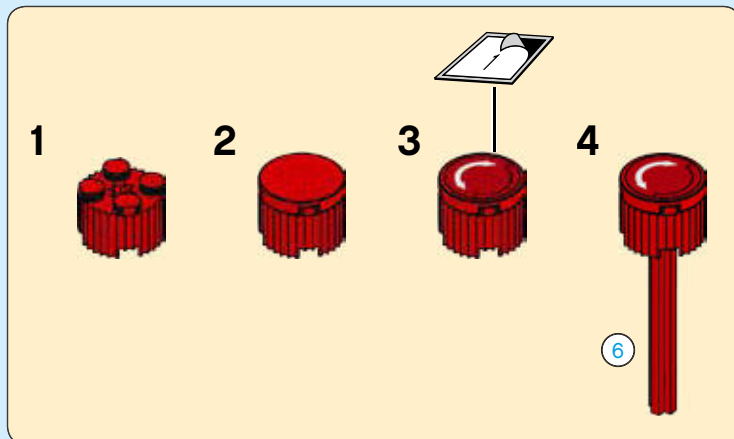

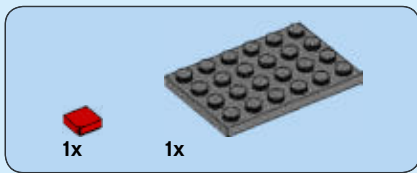

28

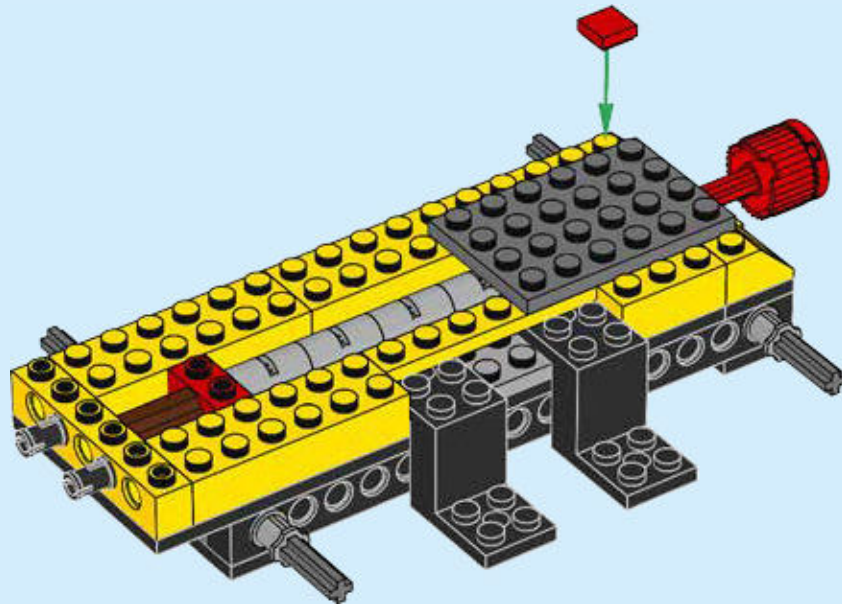

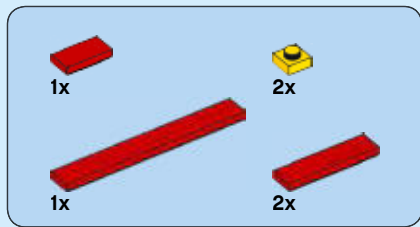

29

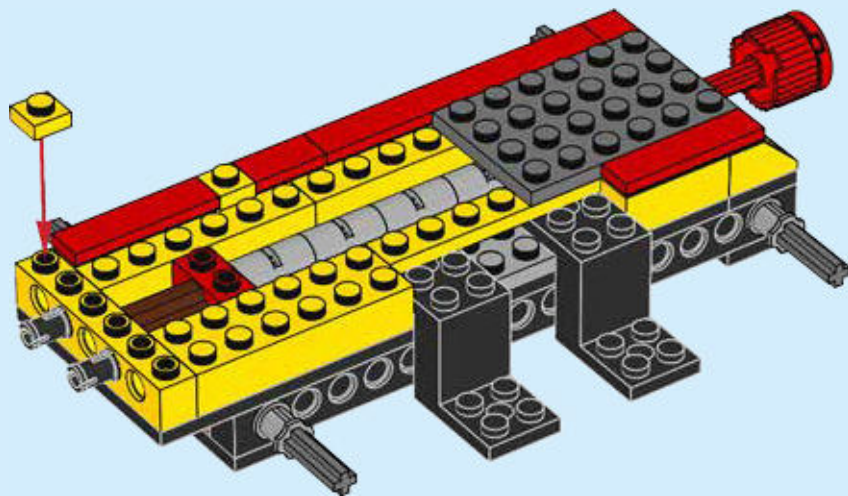

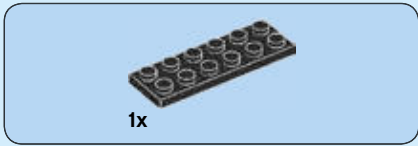

30

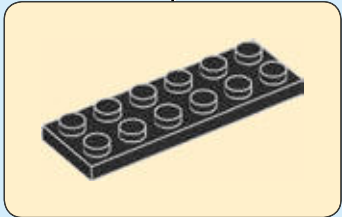
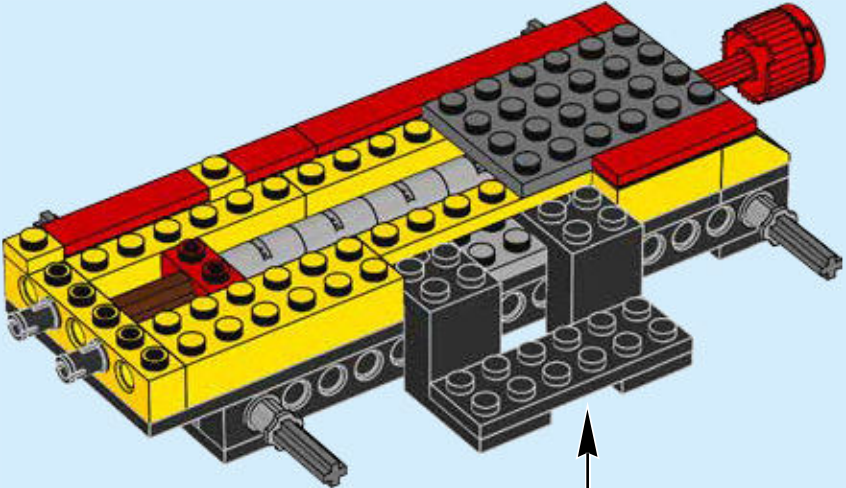



1x

31

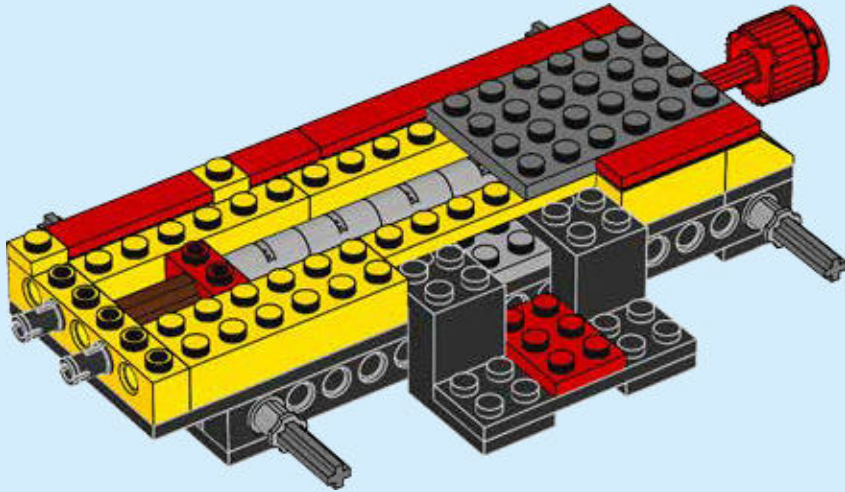

32





2x

32

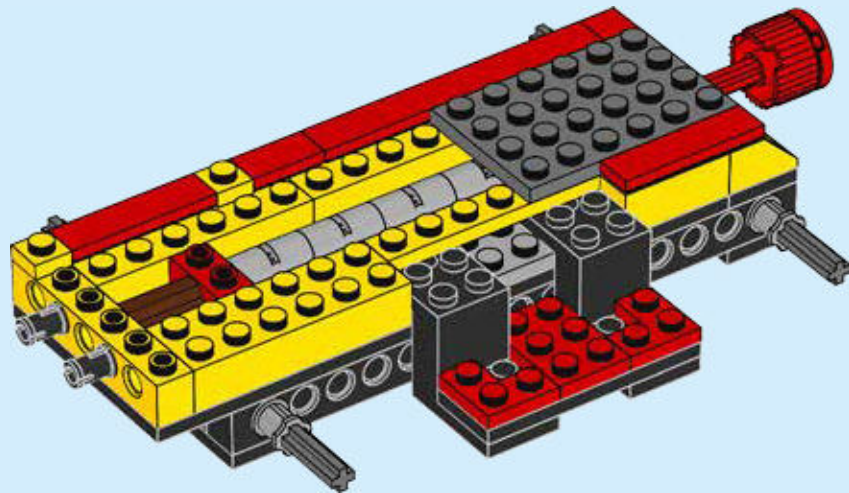



**33**

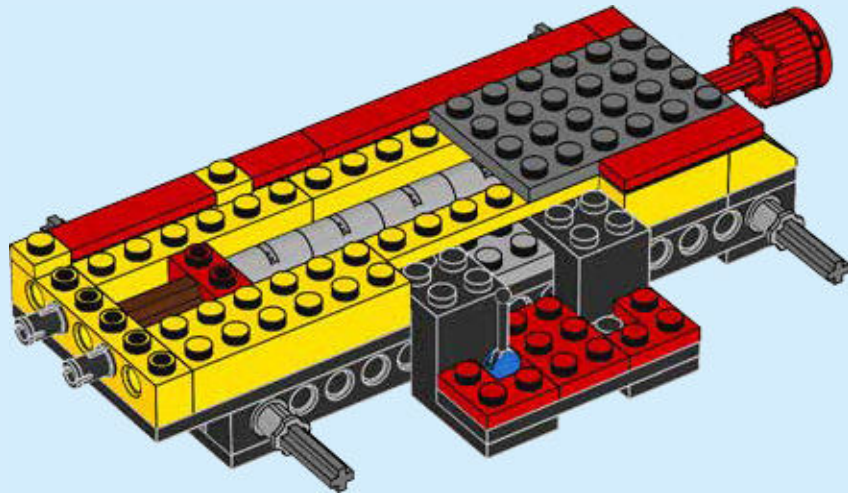

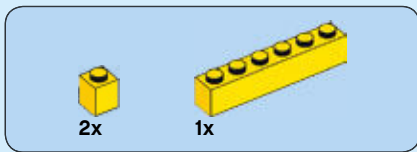

34

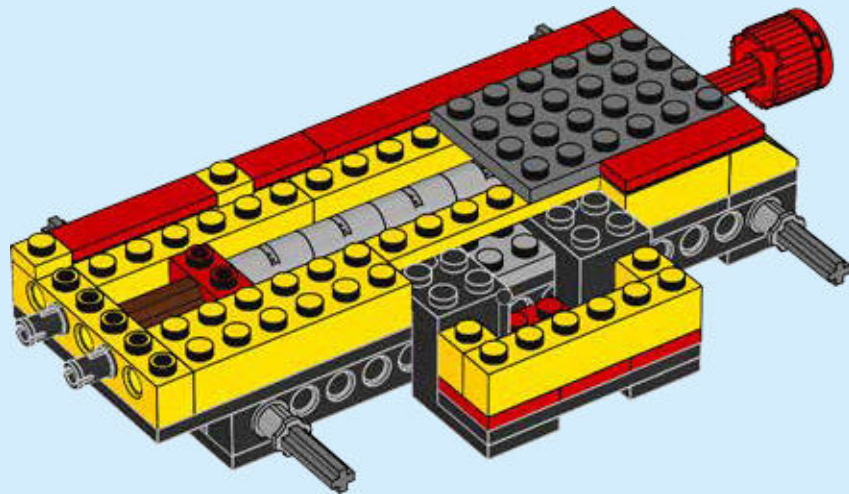



2x



1x

35

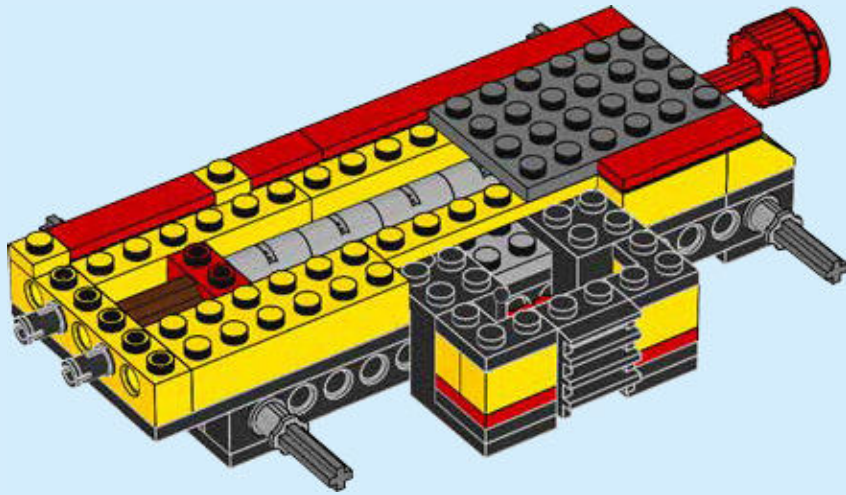

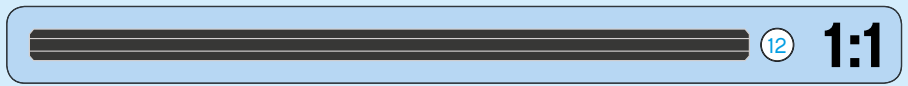
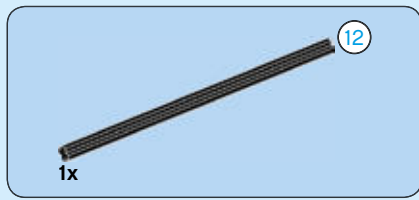

36

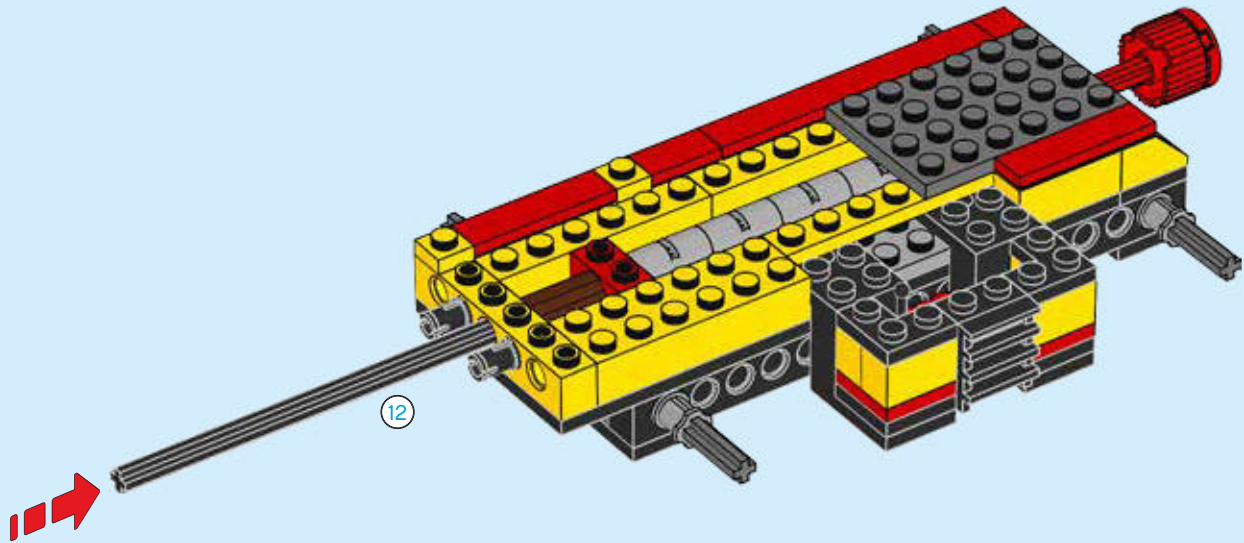

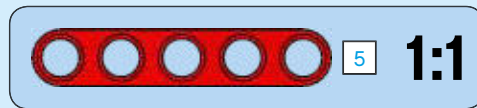

37

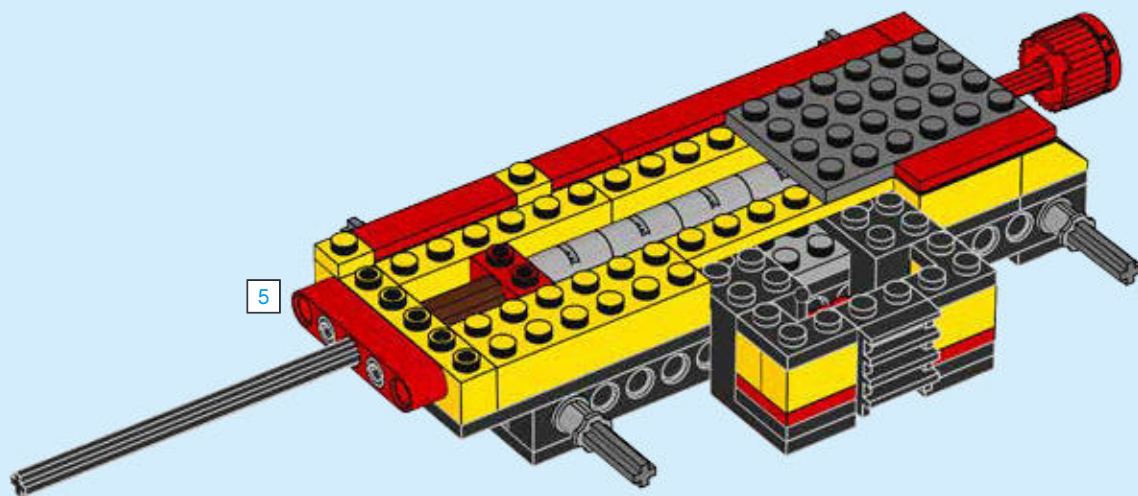



2x

38

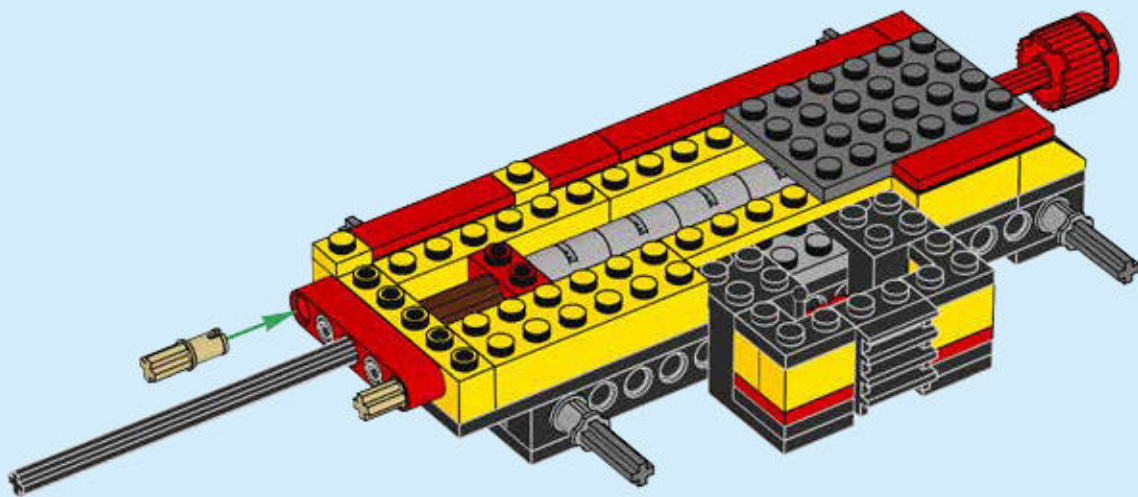



3x

39

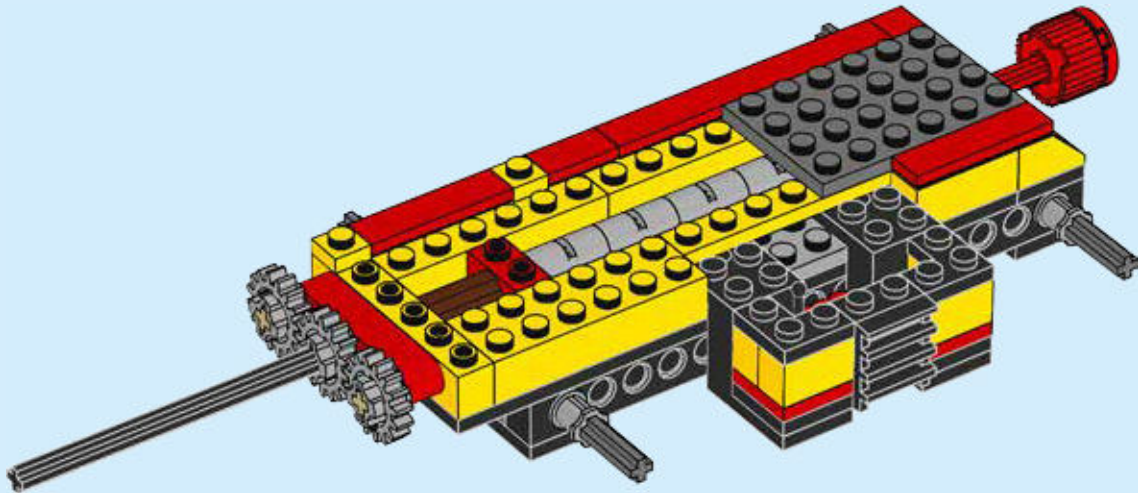

40





40

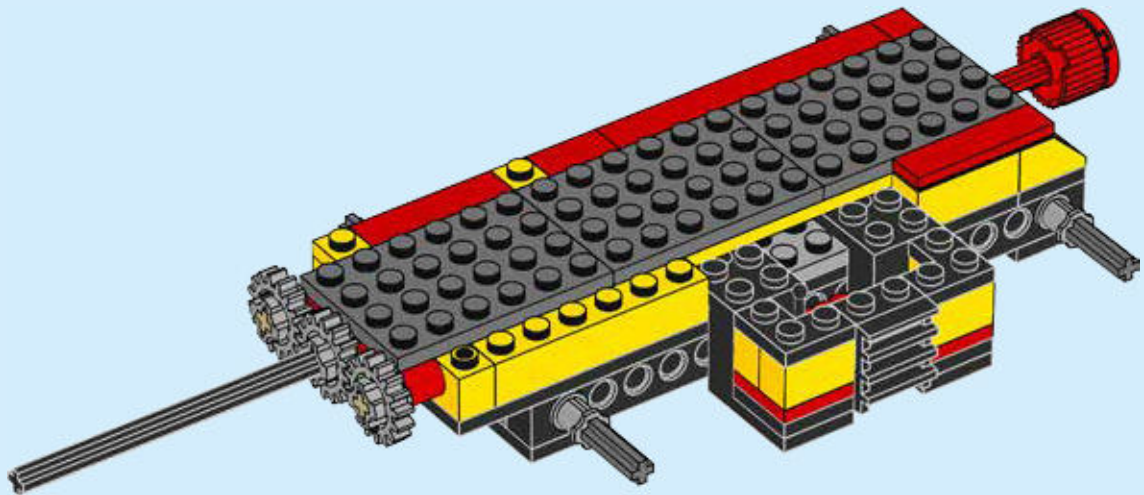



1x



1x

41

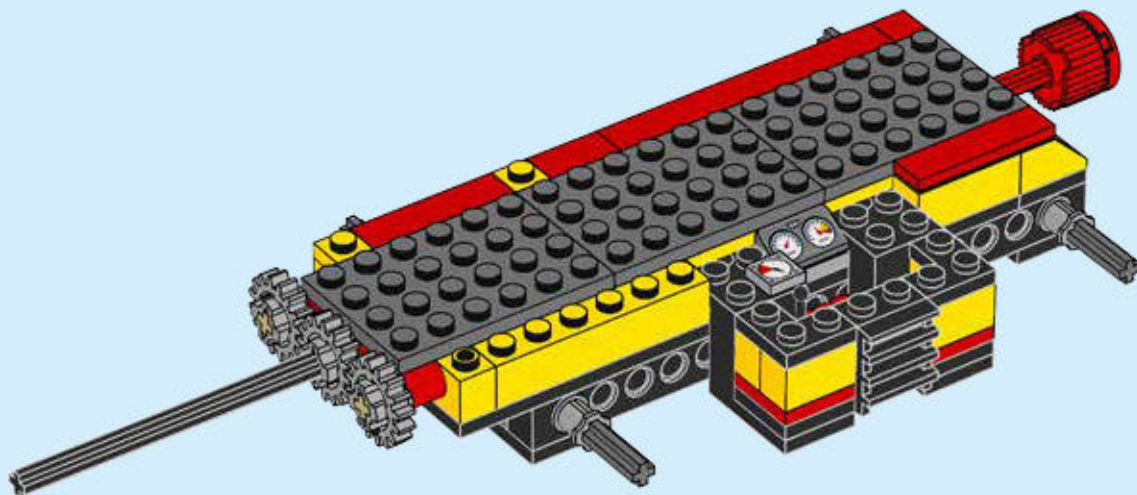

42



42

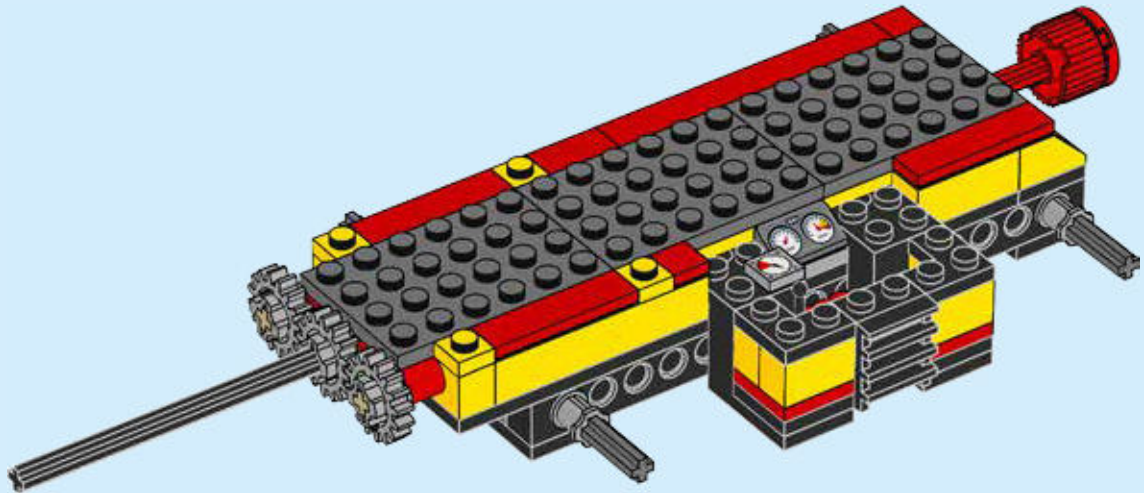



+

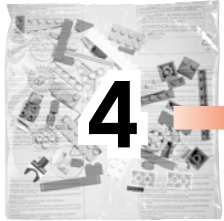

1x

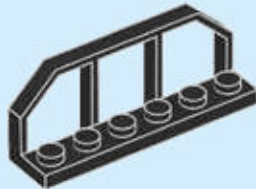

43



1x

44

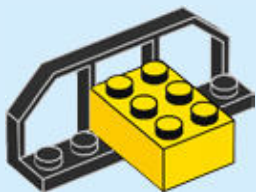

1x



1x

45

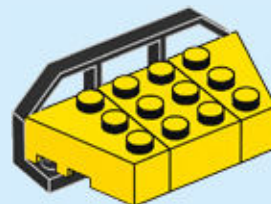



1x

46

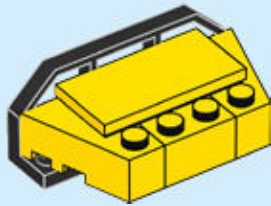

47



48

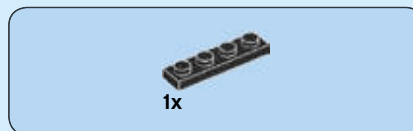



2x

49



48





2x

50

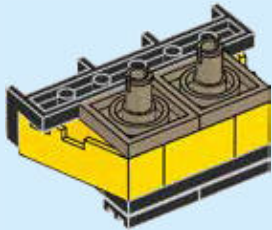
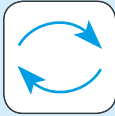

51

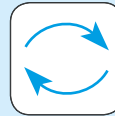

52

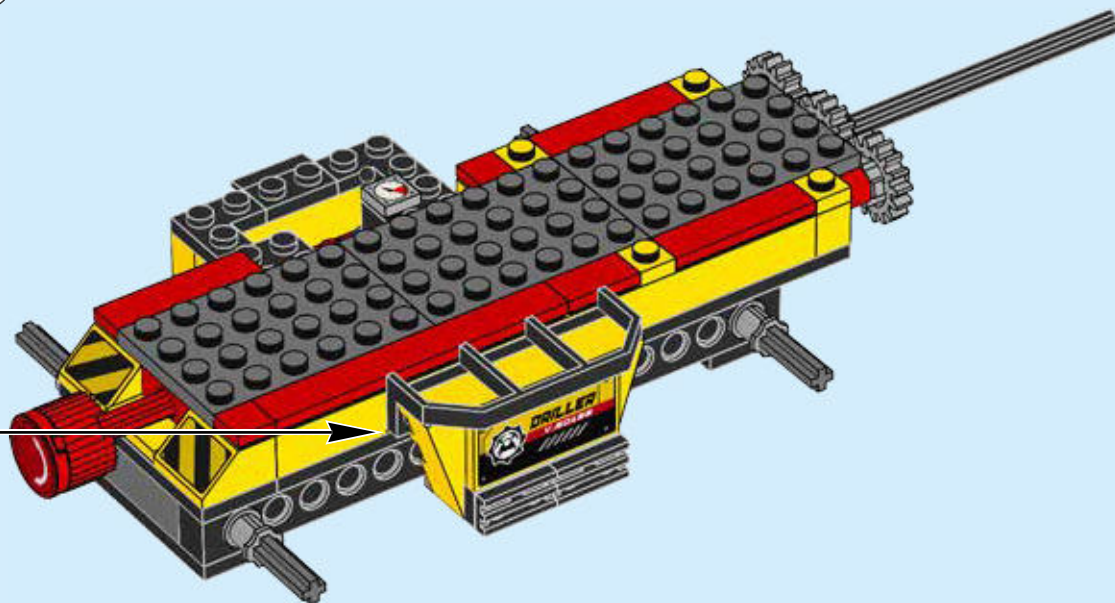
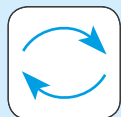



2x

53



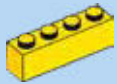

1x

54

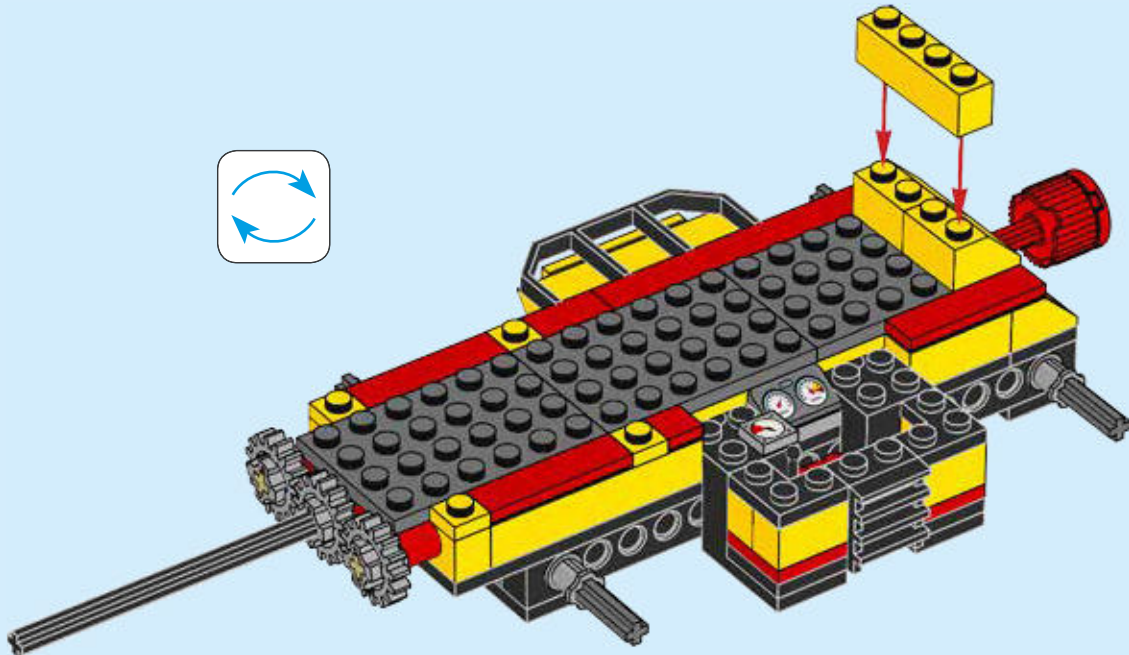
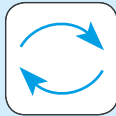



55

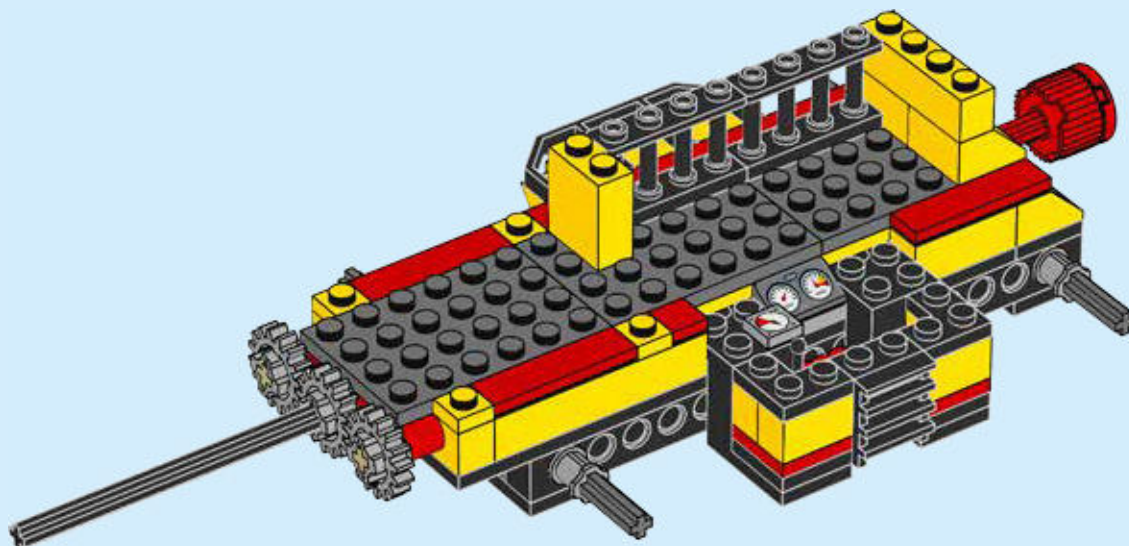



2x

56

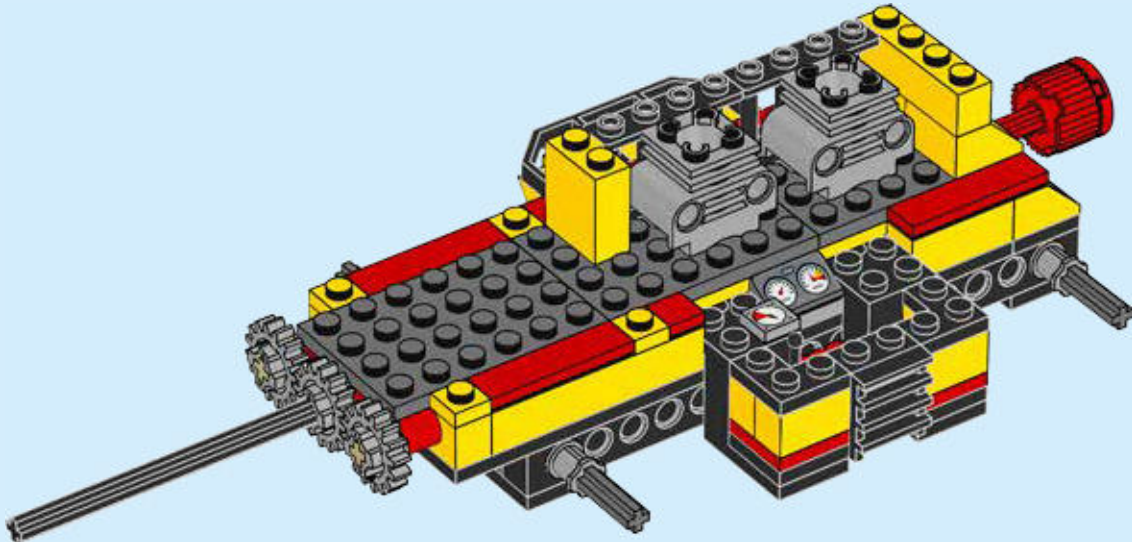

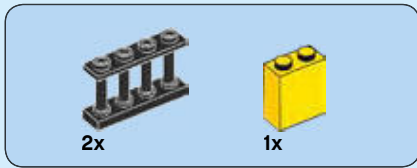

57

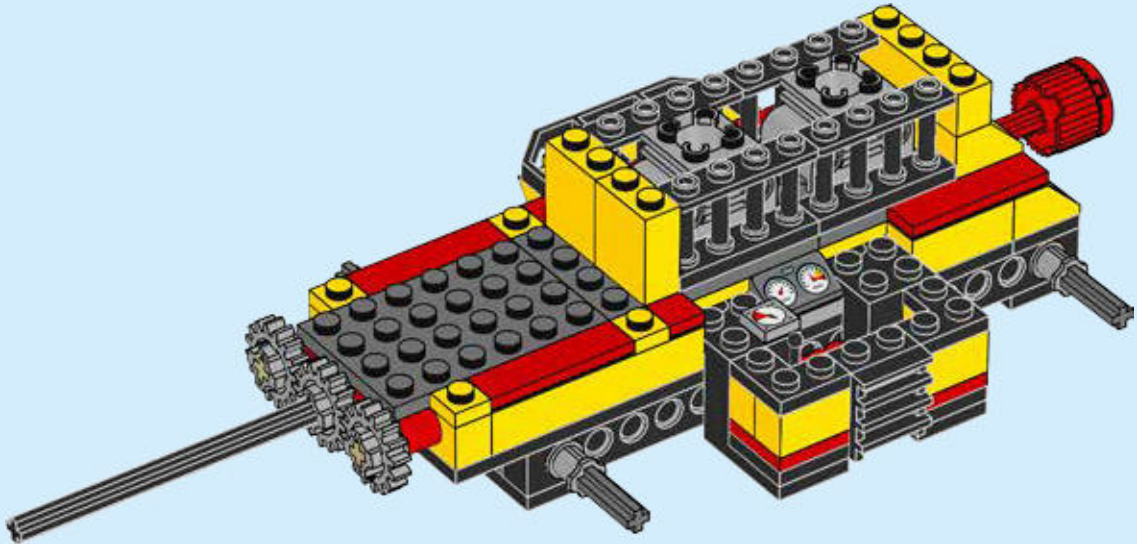

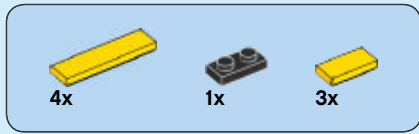

58

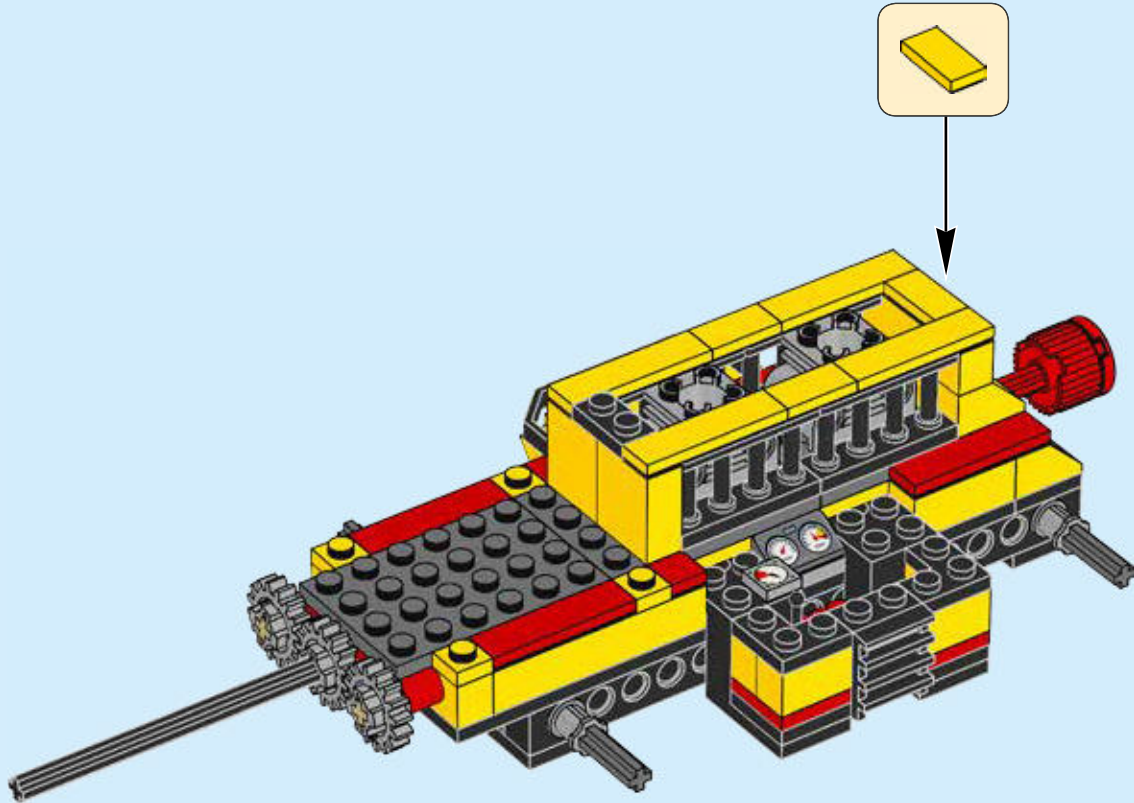





2x

59

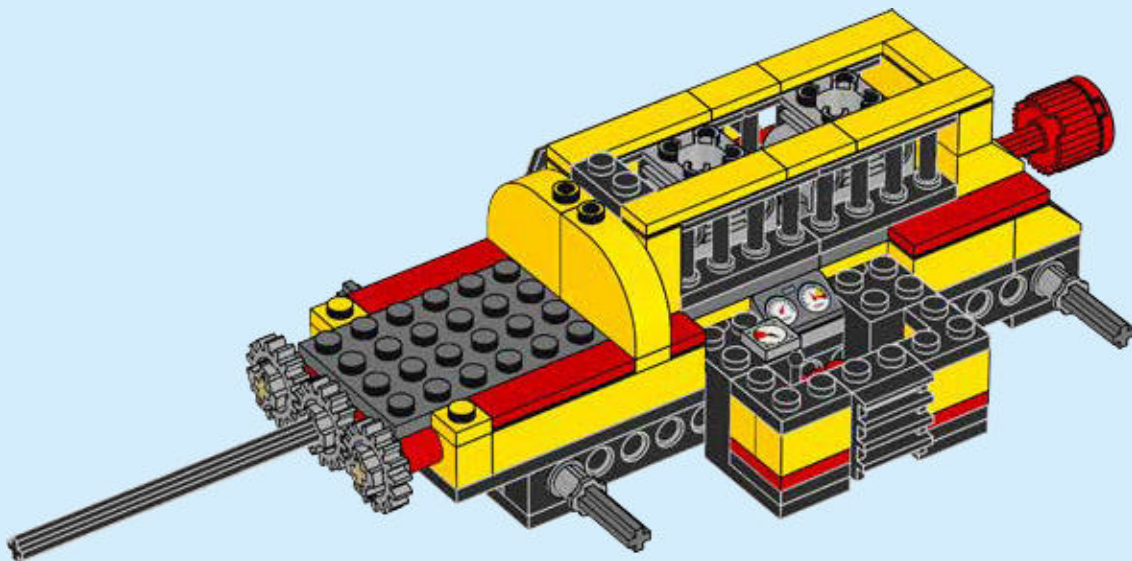



4x

60

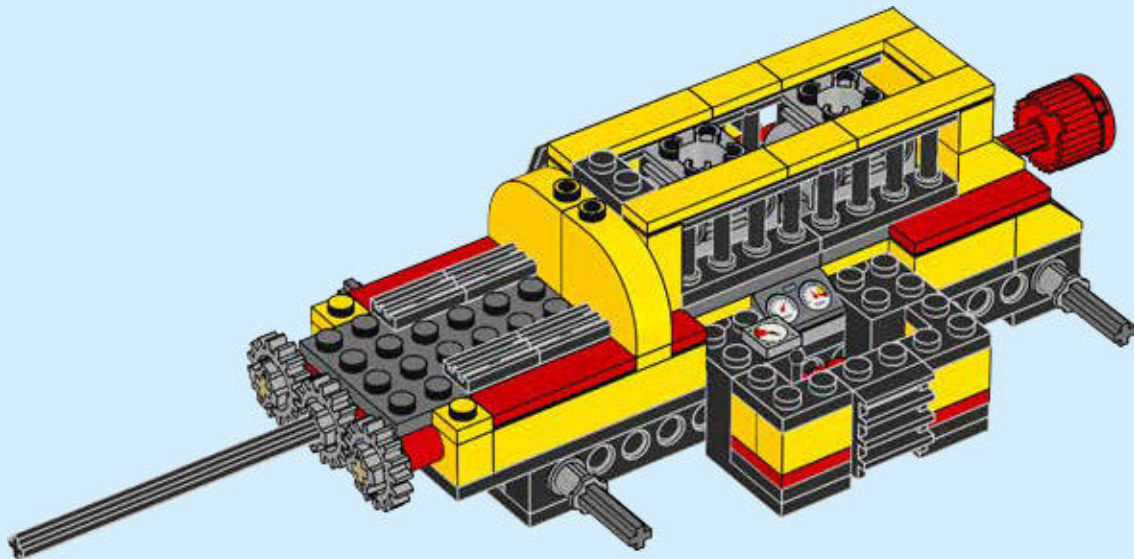



2x

61

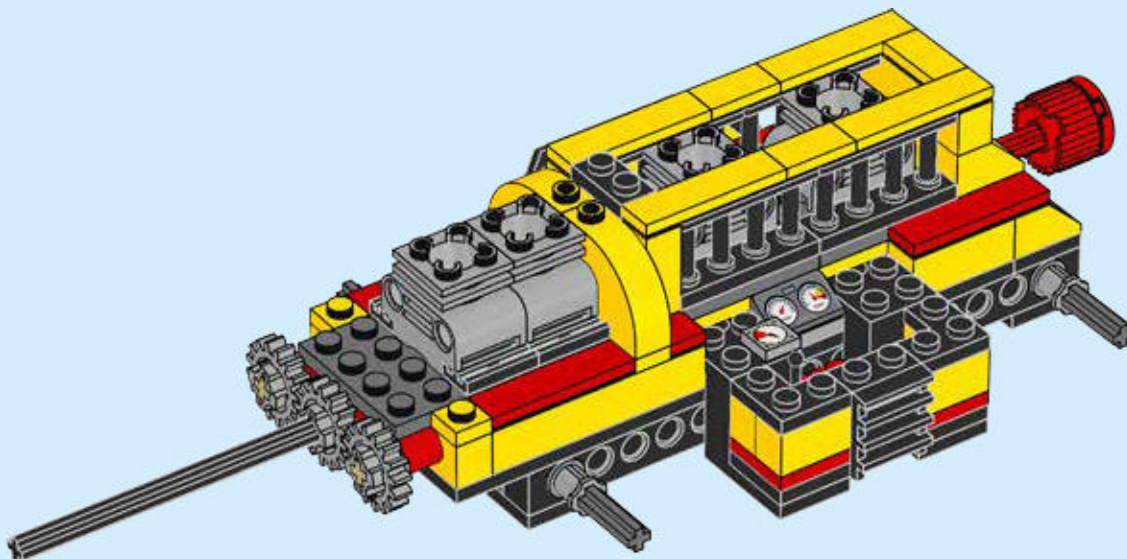



2x

62

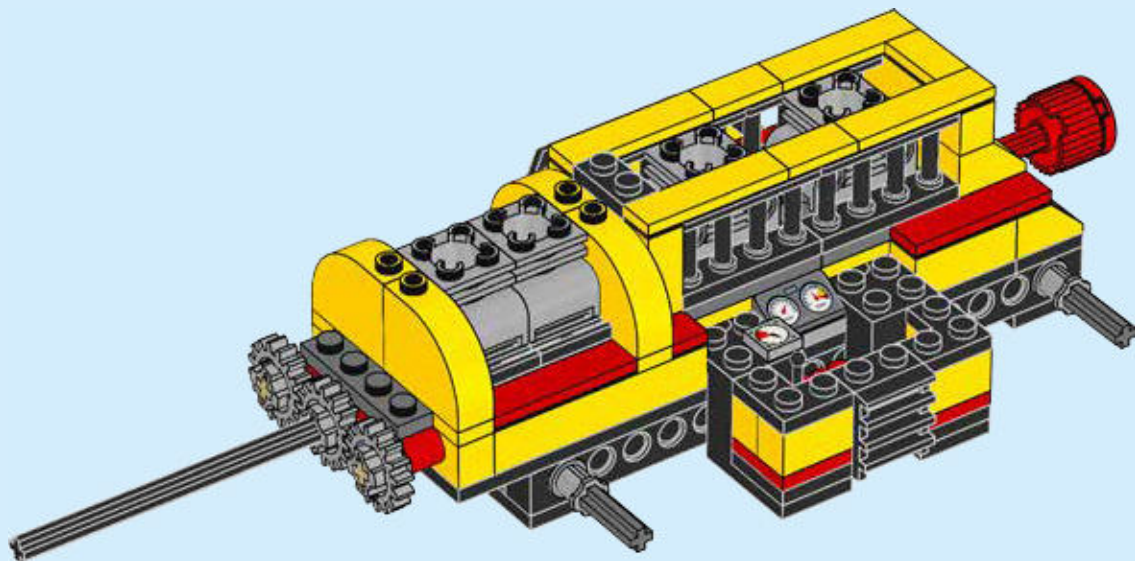



2x



4x

63

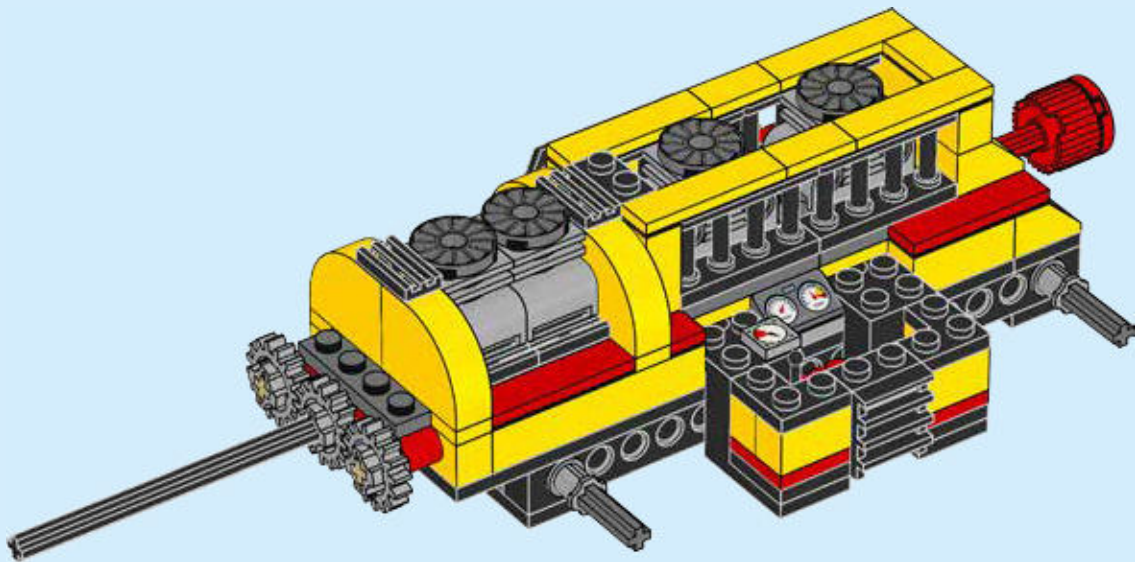

2x



1x

# 64

1



2

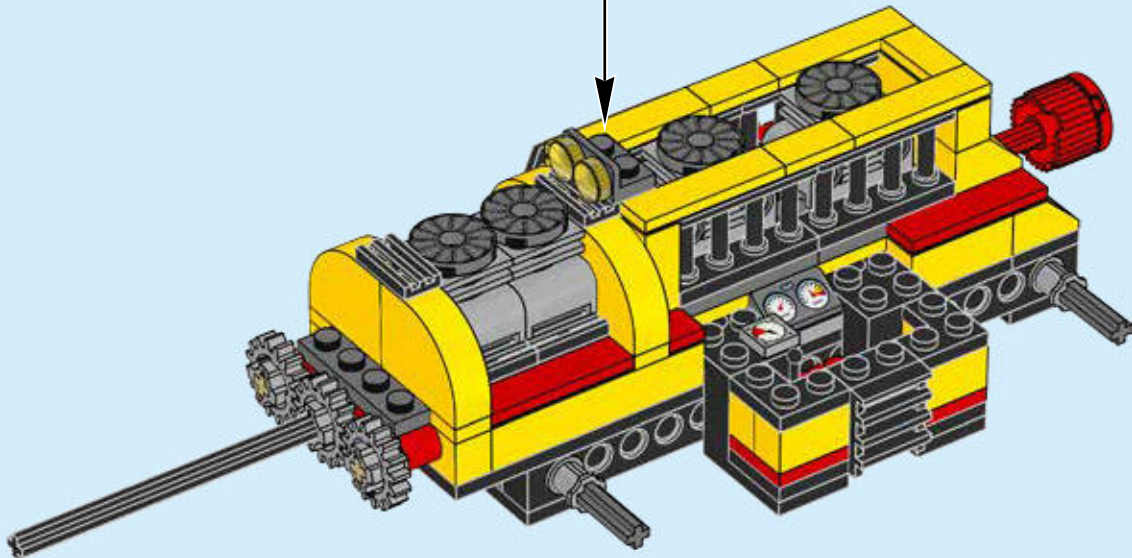



2x

65

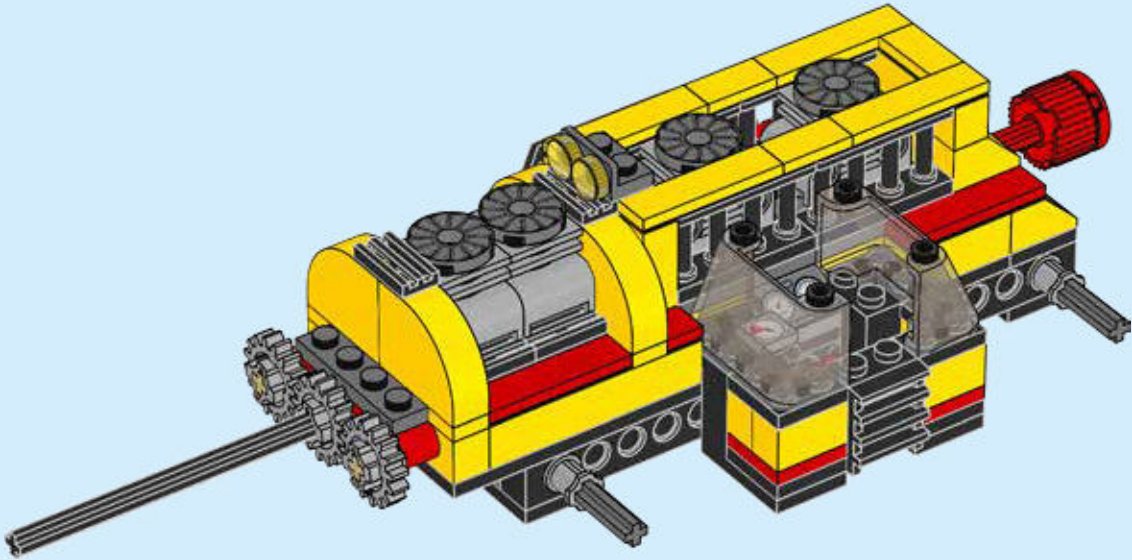



66

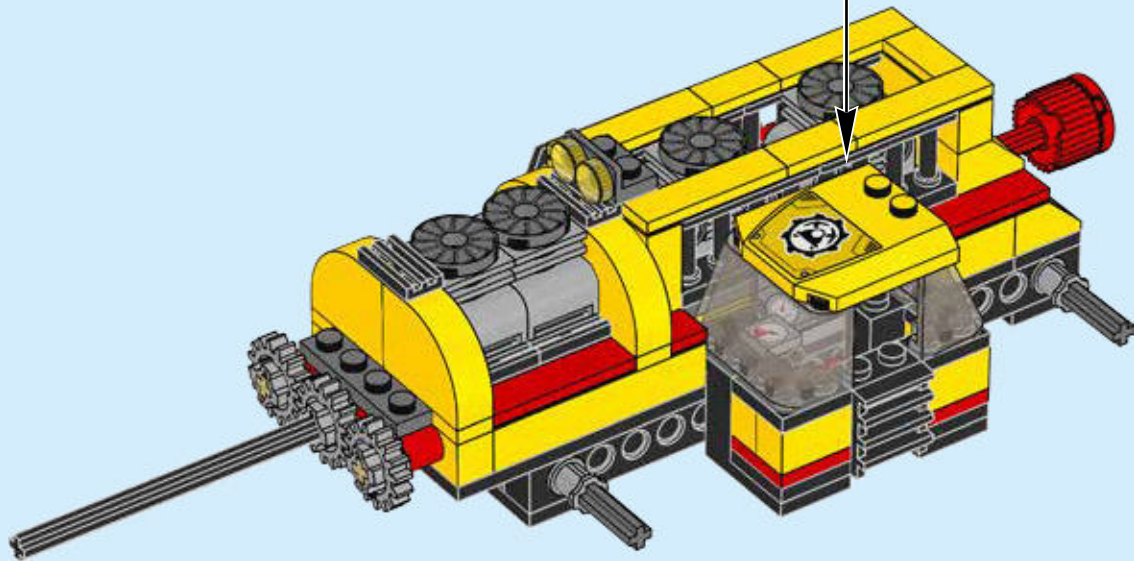
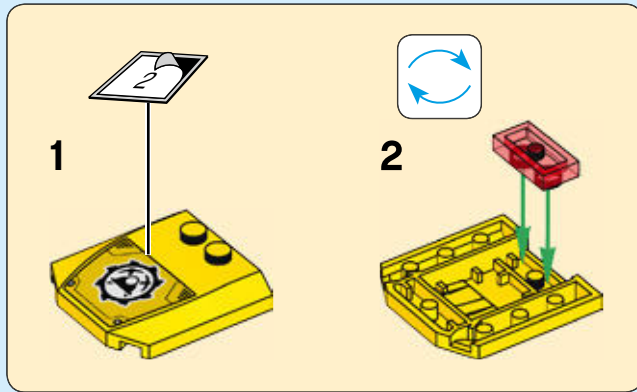



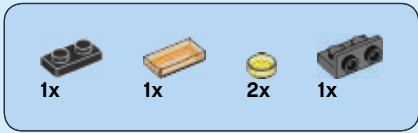

67

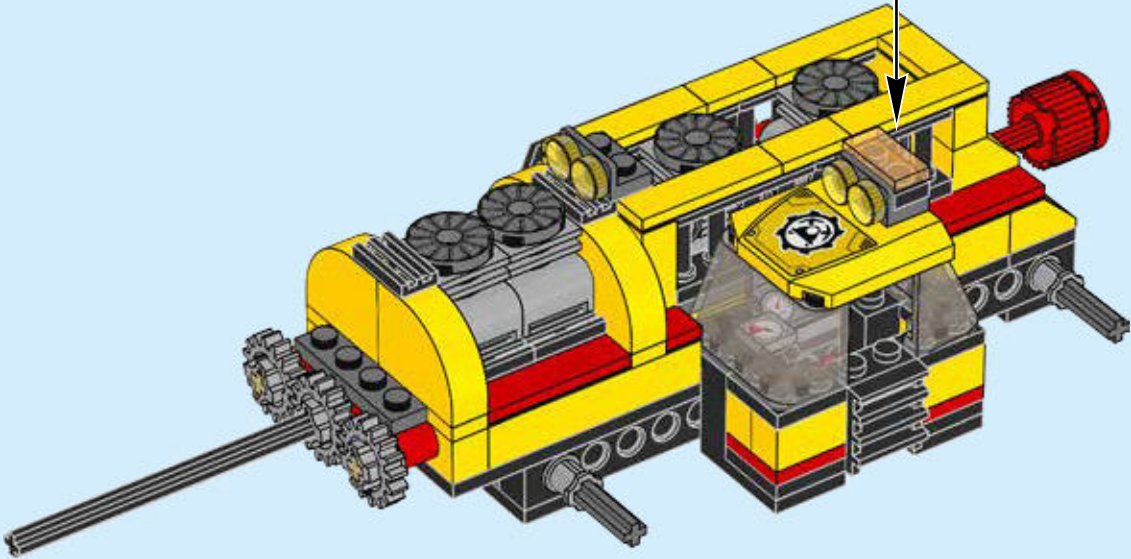
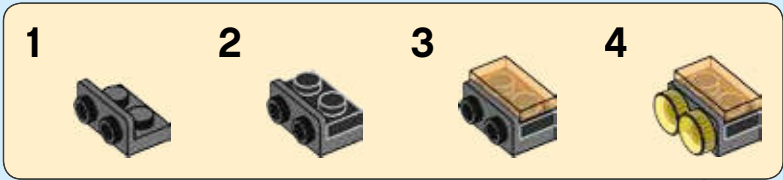

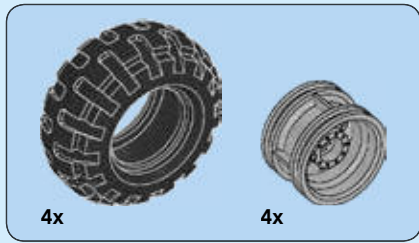

68

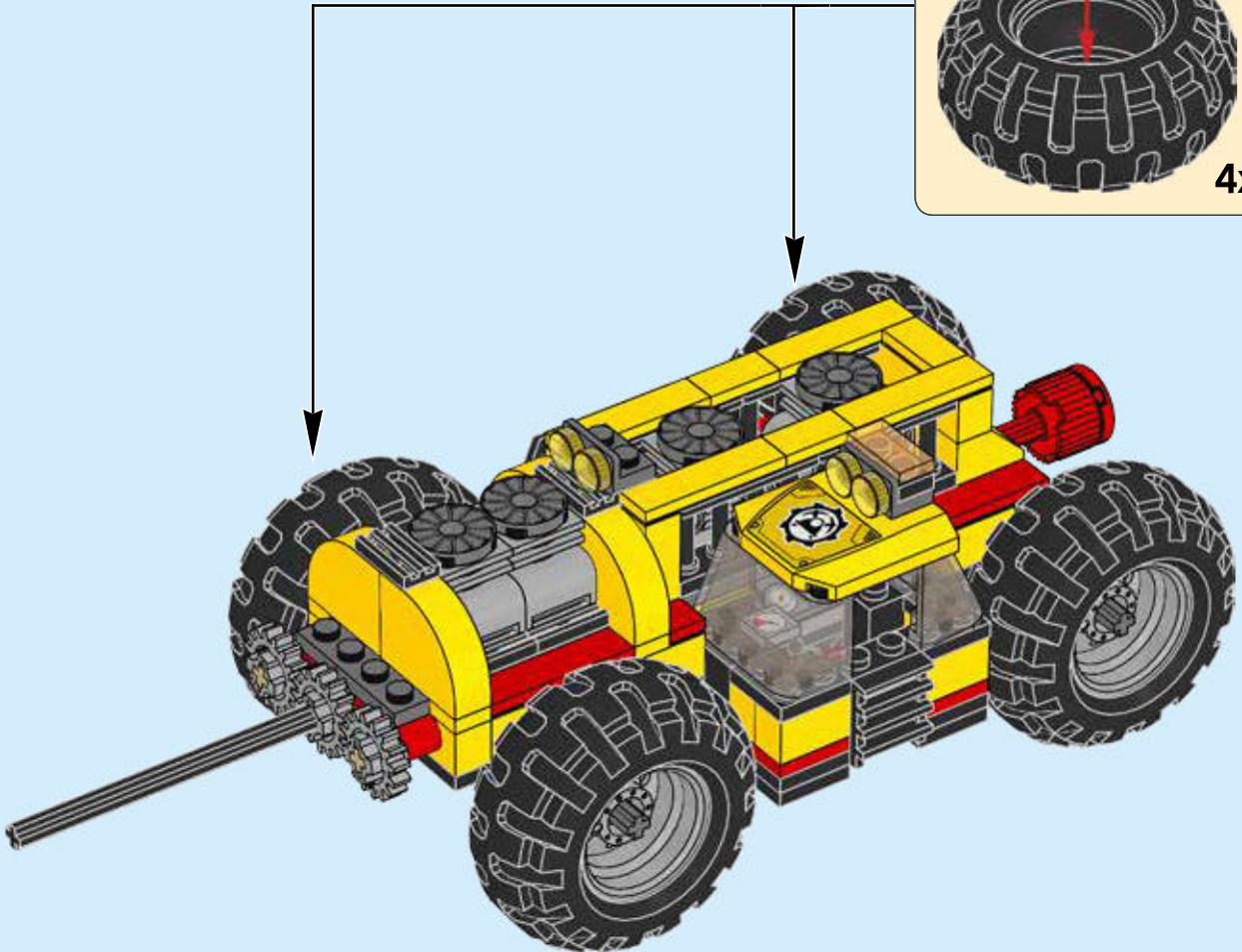
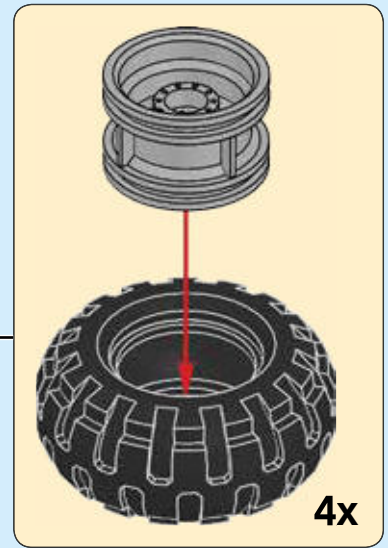



4x

69



4x

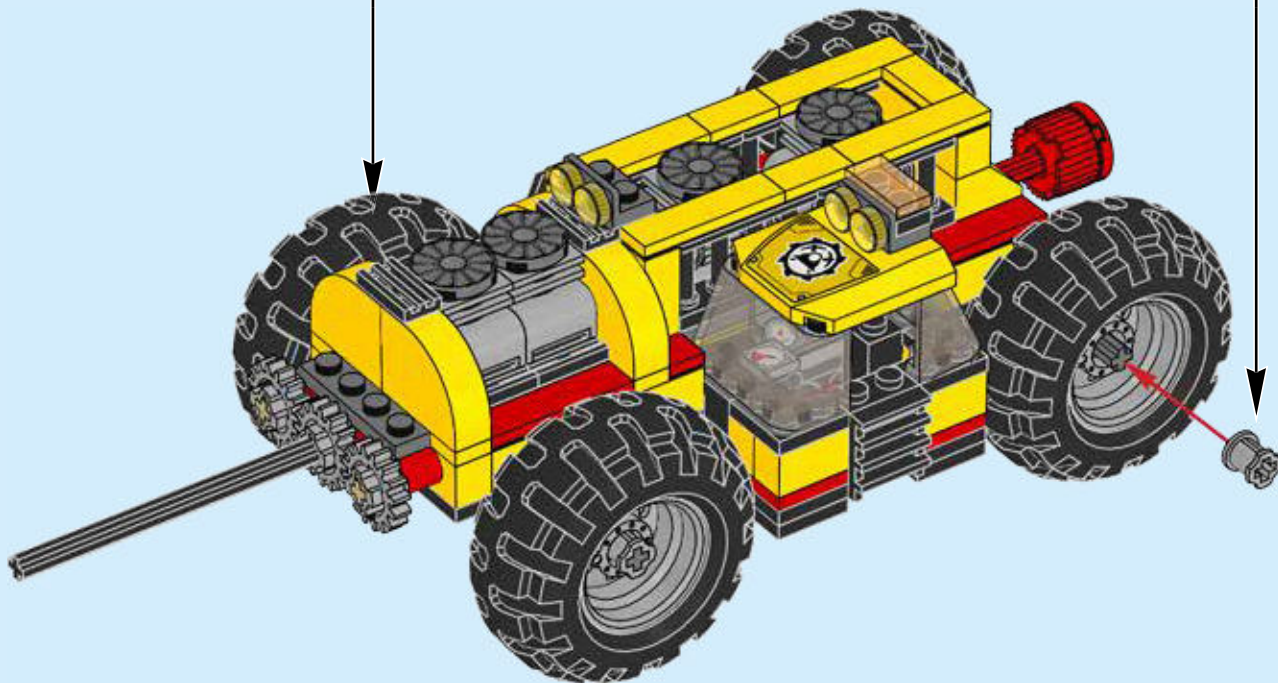

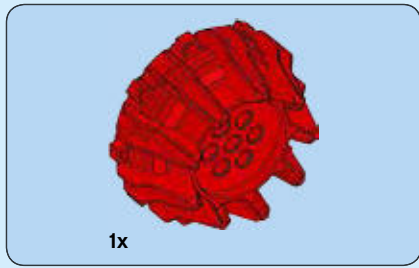

70

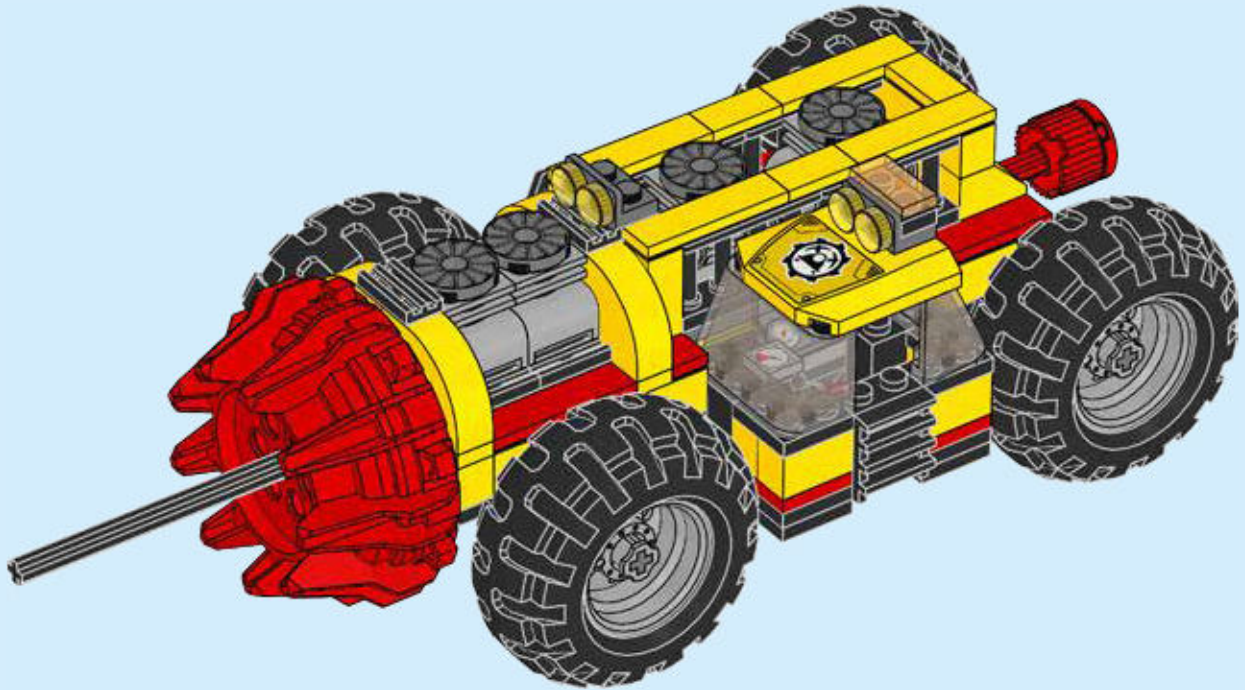



1x

71

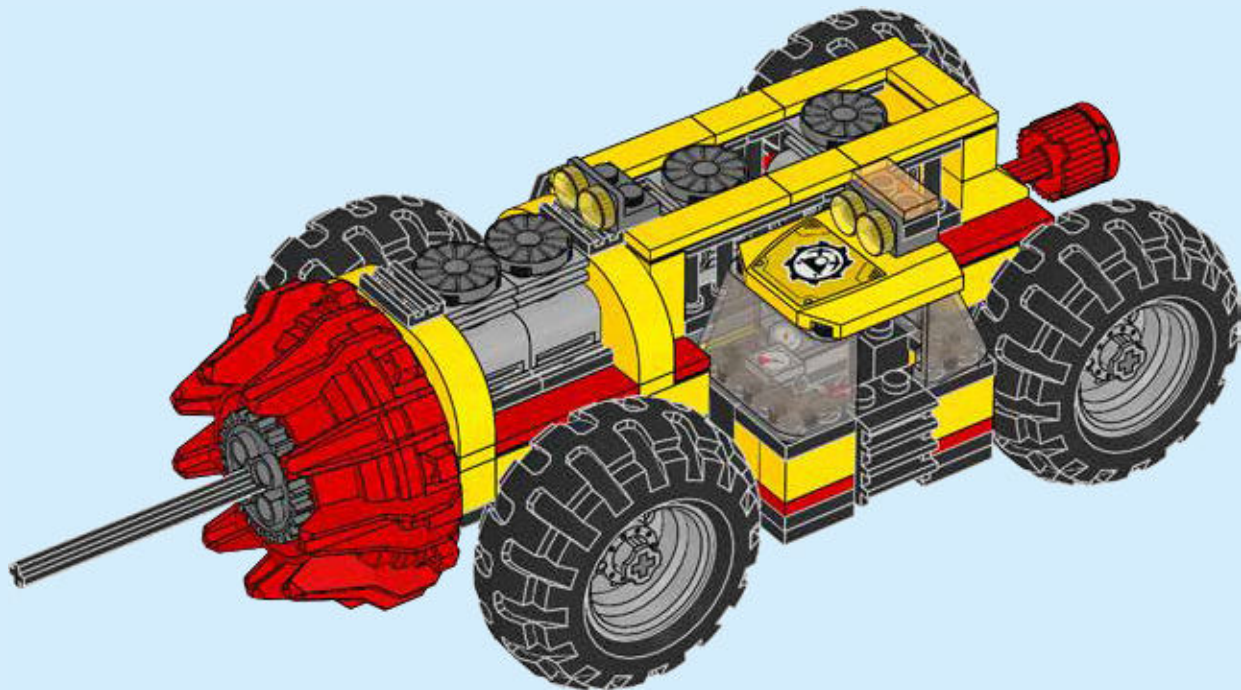



1x

72

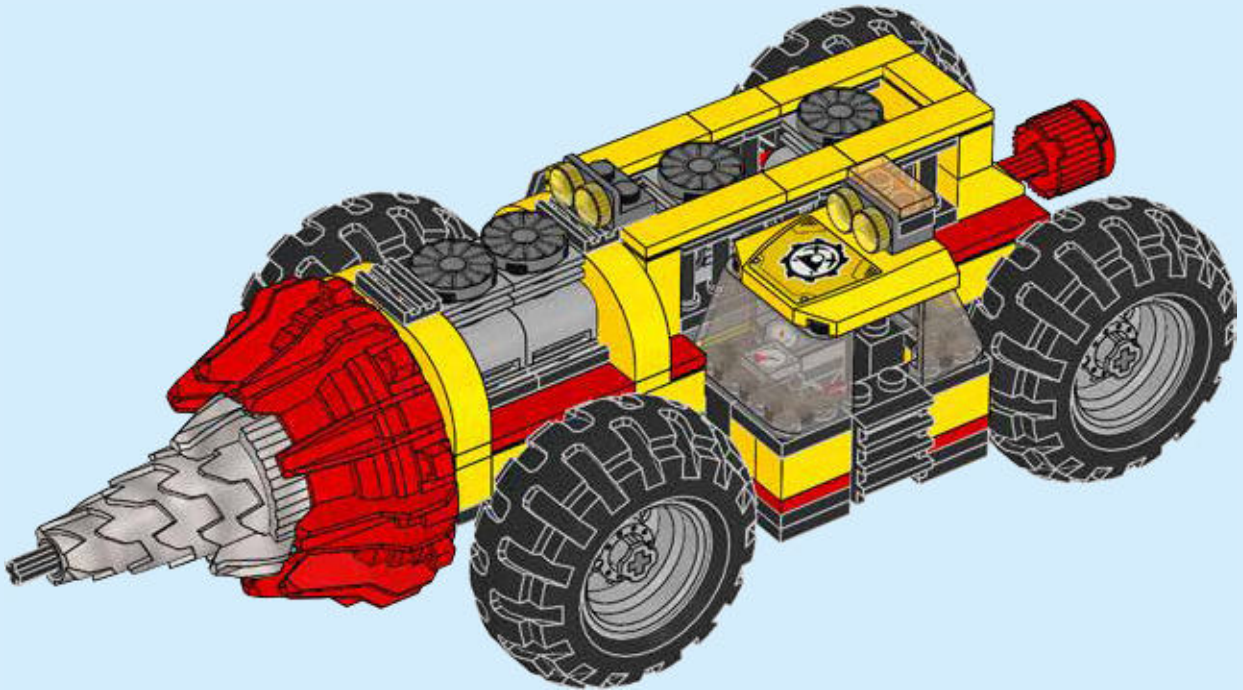



1x

73

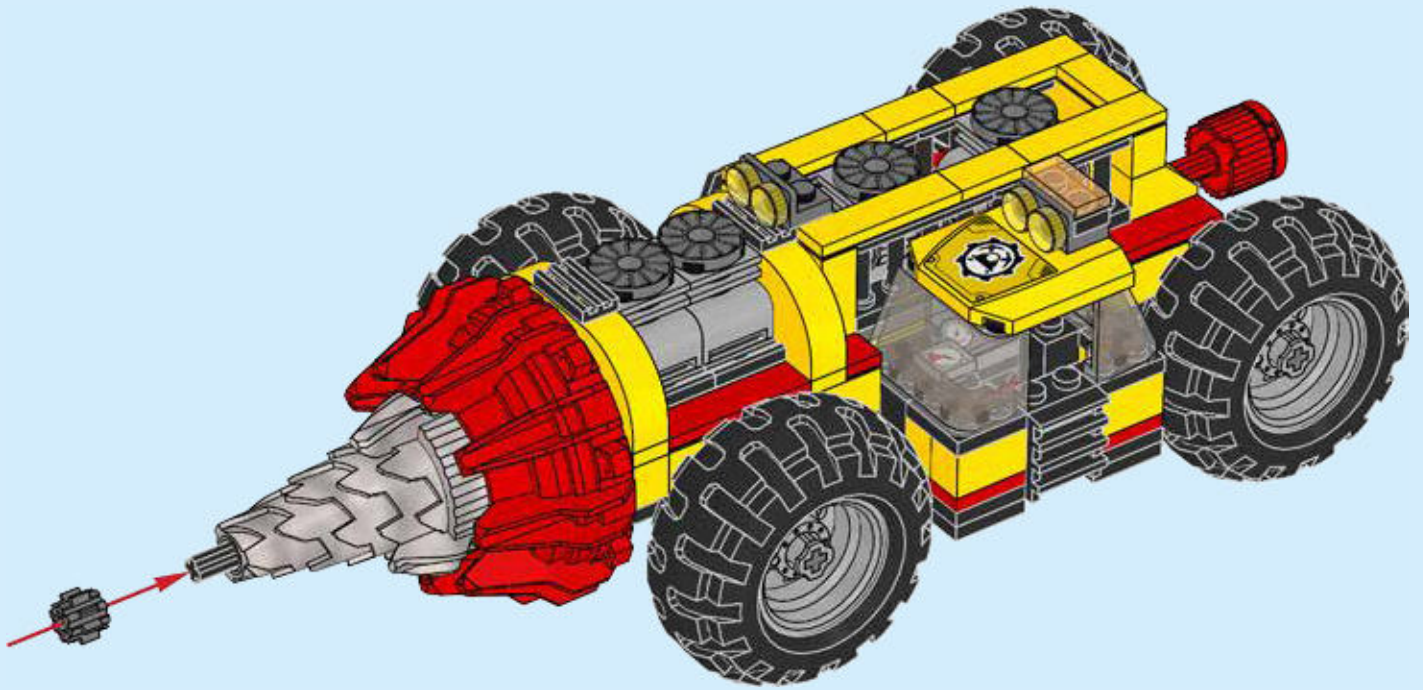

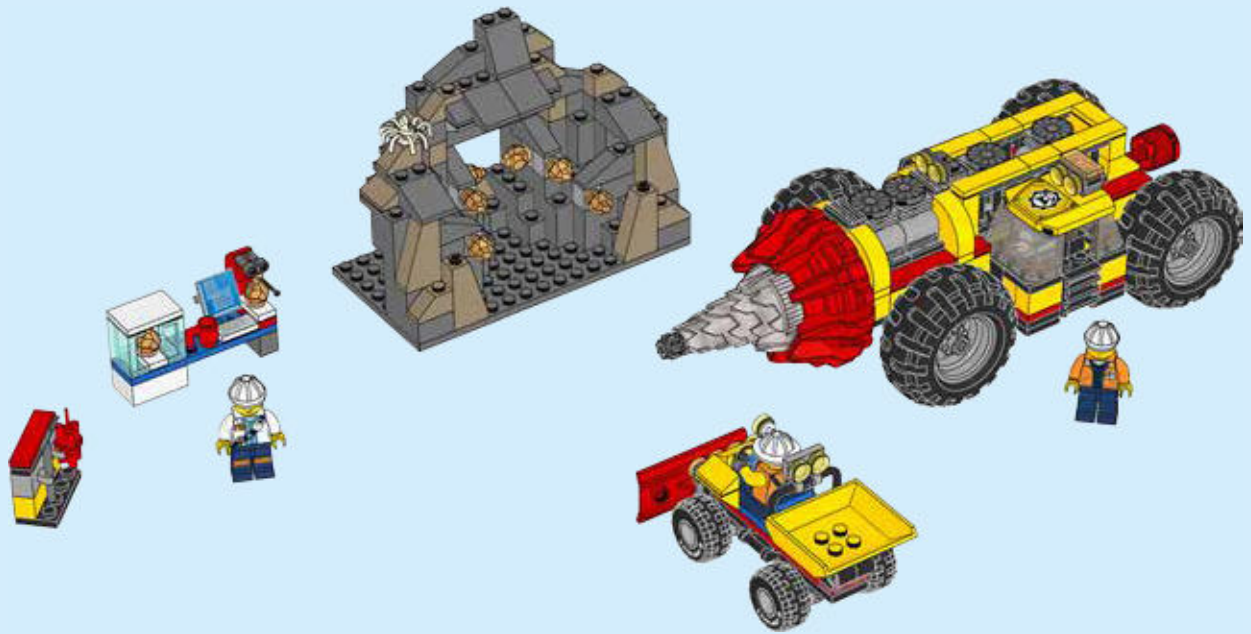



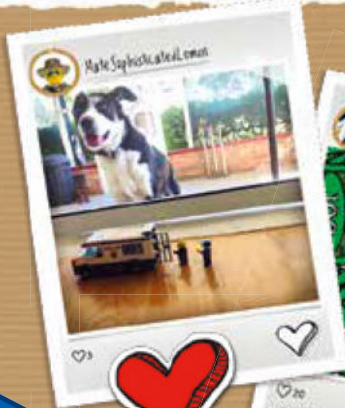



1x  
6112193



1x  
6210452



1x  
4293350



2x  
6051511



1x  
6156667



1x  
300201



2x  
4666579



1x  
4538780



2x  
307021



1x  
389921



1x  
6030266



1x  
6066342



1x  
4650646



3x  
370021



1x  
306921



1x  
306921



1x  
306921



1x  
6184782



2x  
242021



1x  
362321



1x  
302121



4x  
243121



1x  
4142132



1x  
6211845



1x  
6130002



1x  
416221



1x  
6211842



1x  
303421



1x  
302423



1x  
302423



1x  
302423



1x  
302423



1x  
302423



1x  
302423



1x  
370023



1x  
243223



1x  
9566



1x  
302123



1x  
303423



1x  
6174454



1x  
4654328



1x  
6100222



4x  
302424



2x  
300524



3x  
4550348



2x  
4121625



4x  
306924



1x  
302324



1x  
302324



1x  
302324



1x  
302324



1x  
306824



4x  
303924



1x  
6138210



4x  
6211856



1x  
6214772



1x  
6214775



3x  
4181143



1x  
6211850



1x  
4221775



1x  
4296152



1x  
6064043



2x  
4201019



2x  
4640026



1x  
4650500



1x  
4650500



1x  
4650500



1x  
4650500



1x  
4193073



1x  
366624



1x  
389424



1x  
300924



3x  
4181143



1x  
6211850



1x  
4221775



1x  
4296152



1x  
6064043



2x  
4201019



2x  
4640026



1x  
4650500



1x  
4650500



1x  
4650500



1x  
4650500



1x  
4650500



1x  
4650500



1x  
6138217



1x  
658326



4x  
379526



4x  
4297209



2x  
303626



2x  
370826



2x  
370826



2x  
370826



2x  
370826



2x  
370826



2x  
370826



2x  
370826



3x  
4121715



8x  
241226



3x  
302326



2x  
6171066



2x  
6171066

5

6

12



4

**Customer Service**  
**Kundenservice**  
**Service Consommateurs**  
**Servicio Al Consumidor**  
**LEGO.com/service or dial**  
  
**: 00800 5346 5555**  
**: 1-800-422-5346**



# WIN

GO TO [WWW.LEGO.COM/PRODUCTFEEDBACK](http://WWW.LEGO.COM/PRODUCTFEEDBACK) AND  
GIVE US YOUR SHORT **FEEDBACK** ABOUT THIS  
LEGO® SET FOR A CHANCE TO WIN  
A COOL LEGO PRIZE.

Terms & Conditions apply

# LEGO.com/productfeedback

## GEWINNE

Erzähle uns auf  
[www.LEGO.com/productfeedback](http://www.LEGO.com/productfeedback)

etwas über die Erfahrungen, die du mit  
diesem LEGO® Set gemacht hast, und  
sichere dir die Chance auf einen coolen  
LEGO Preis!

Es gelten die Teilnahmebedingungen

## GAGNE

Rends-toi sur  
[www.LEGO.com/productfeedback](http://www.LEGO.com/productfeedback)

et donne-nous quelques commentaires  
sur ce produit LEGO® pour avoir une  
chance de gagner un prix LEGO !

Voir Conditions Générales

## GANANA

Visita  
[www.LEGO.com/productfeedback](http://www.LEGO.com/productfeedback)

y envíanos tu opinión acerca de este set  
LEGO®. ¡Participarás en el sorteo de un  
premio LEGO!

Términos y Condiciones aplicables

## 获取奖品

登录  
[www.LEGO.com/productfeedback](http://www.LEGO.com/productfeedback)

给出关于此乐高®套装的简短反馈，  
就有机会获得炫酷乐高奖品

《条款及条件》适用