

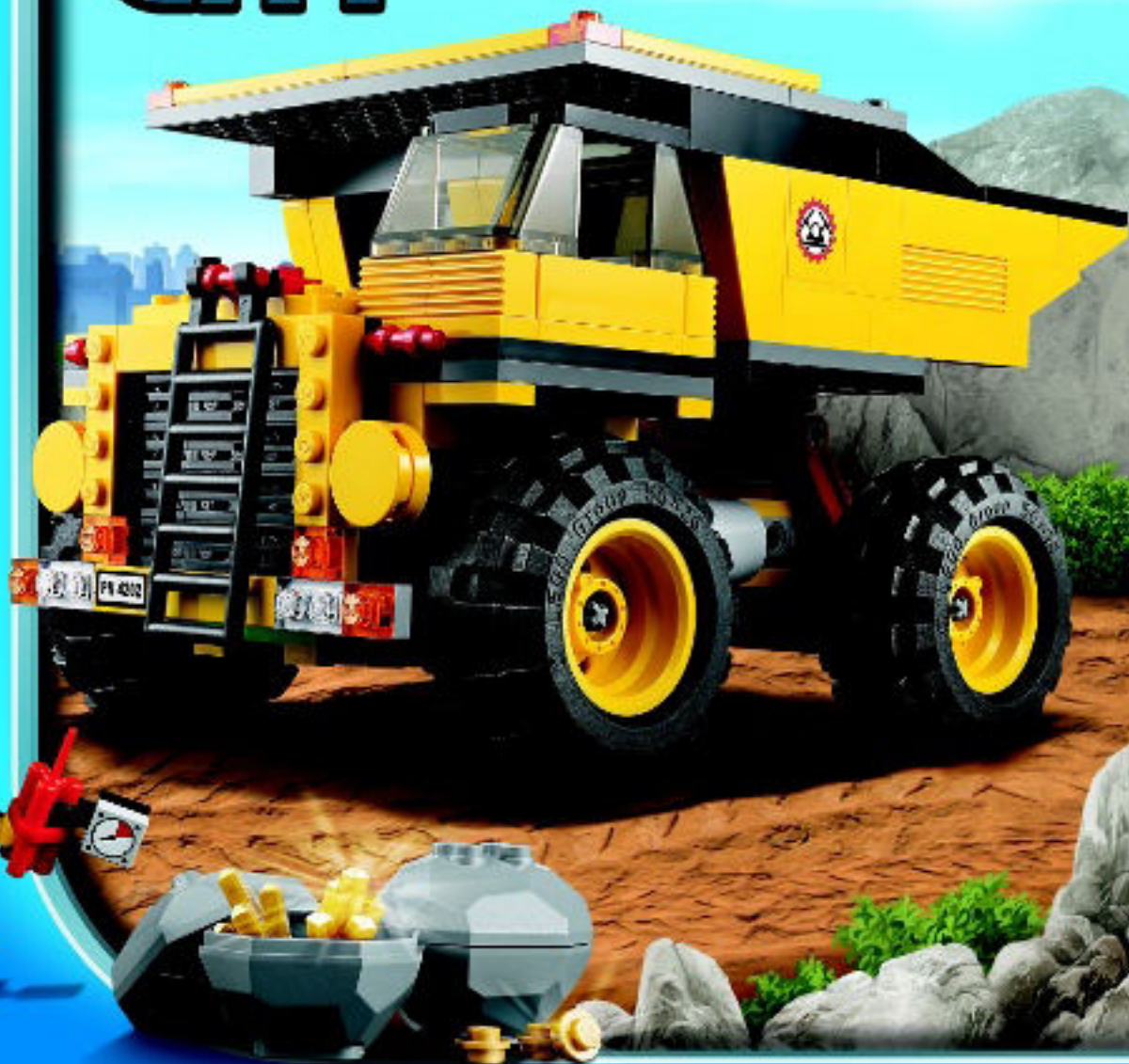

CITY

4202

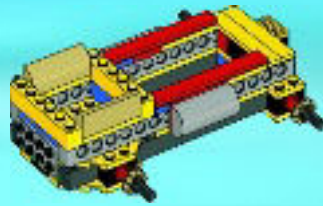



1

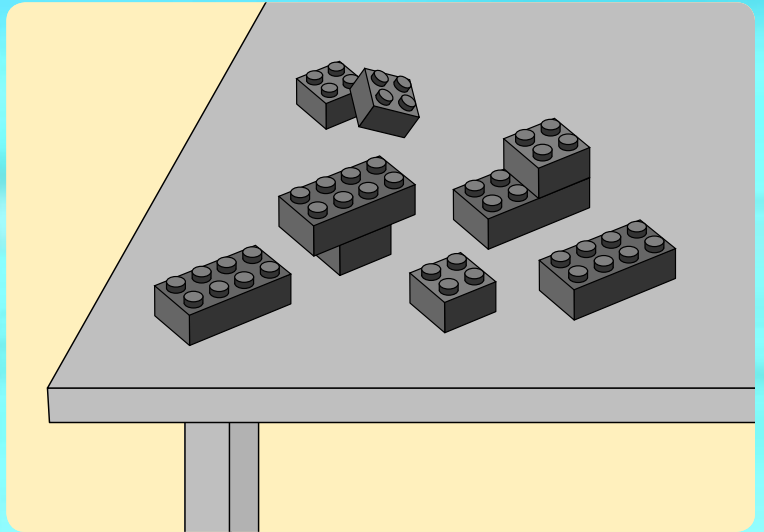
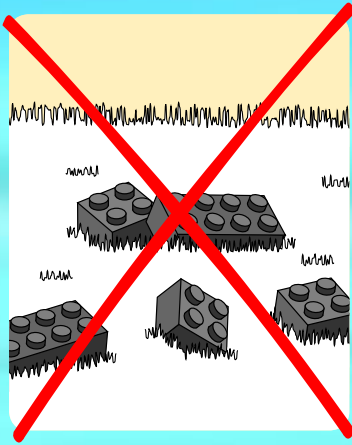

2

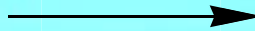

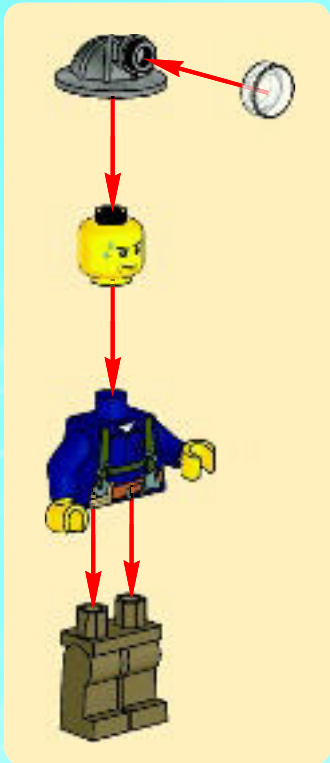
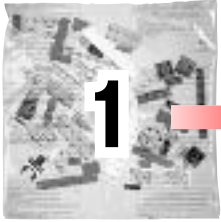

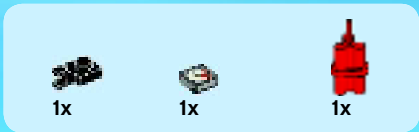

1

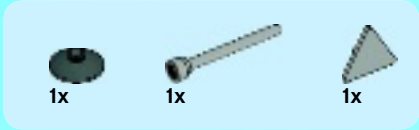
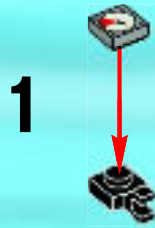

2

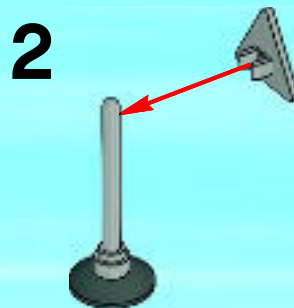
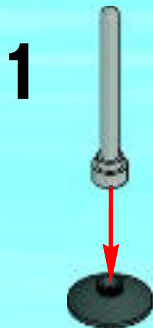

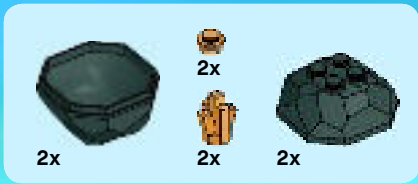

3

1

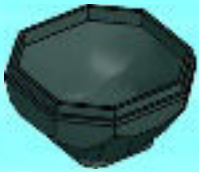

2



3



2x



1x

1



1x

2





2x

3

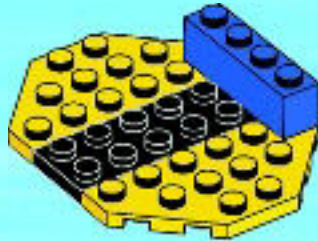



1x



1x

4

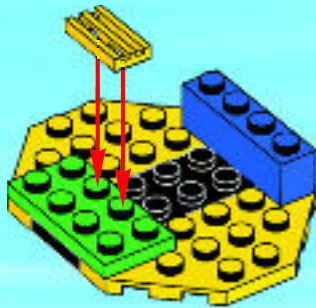

2x

5

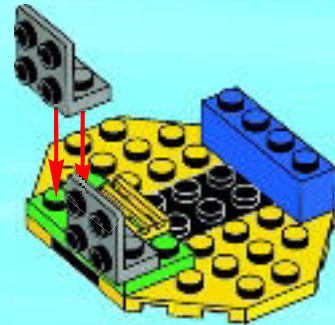

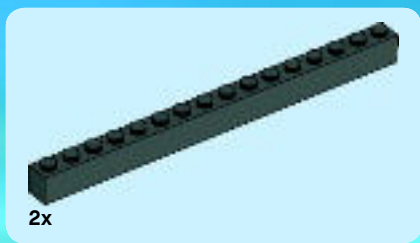

6

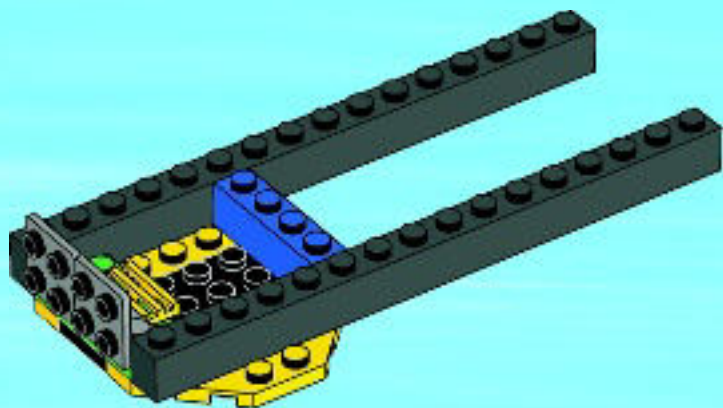

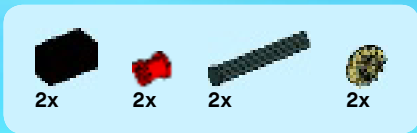

7

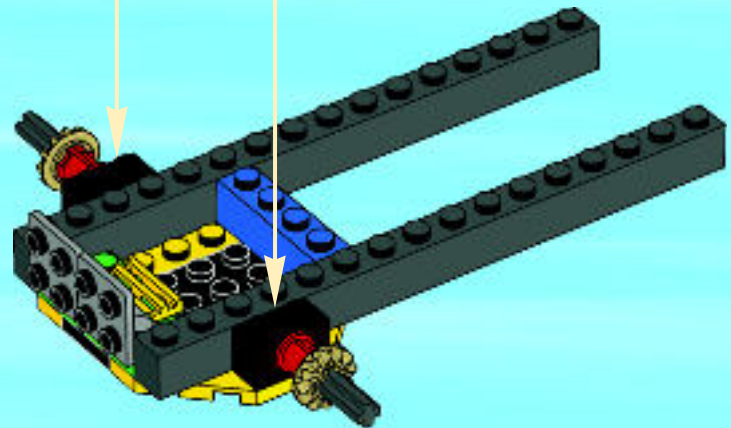
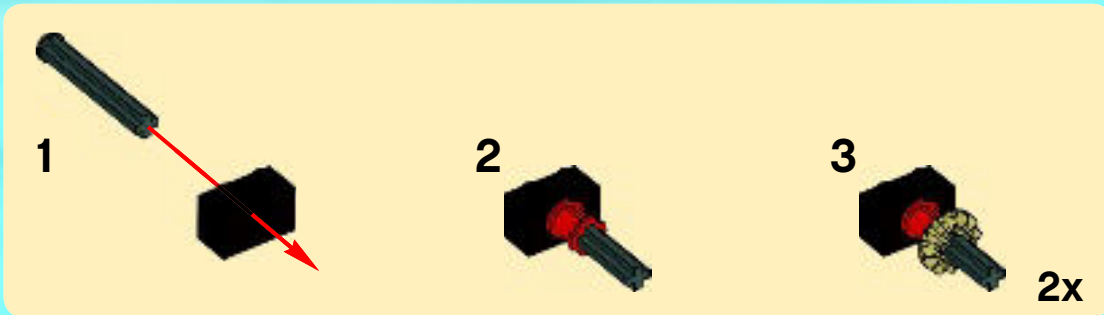



1x

8

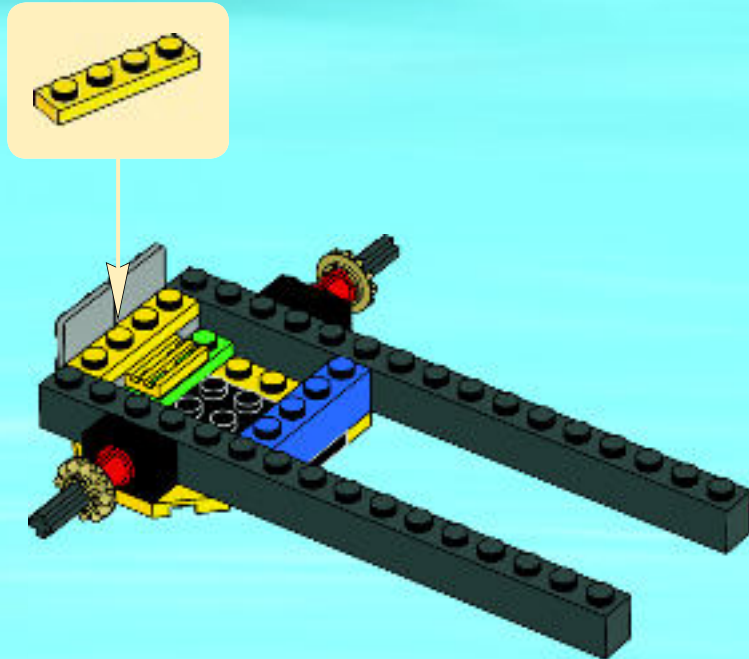



2x



1x

9

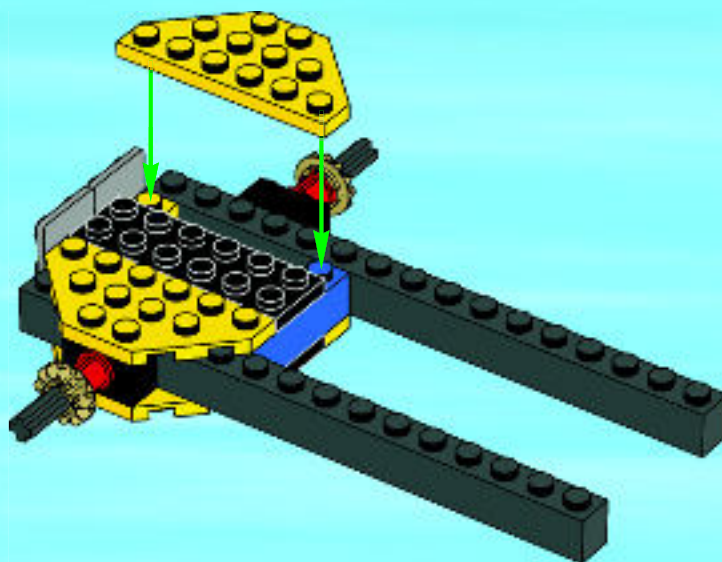

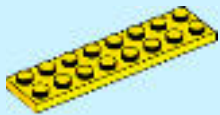

1x

10

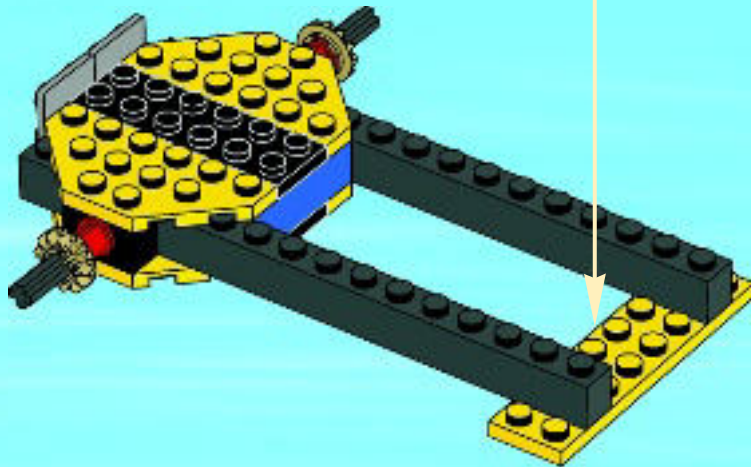
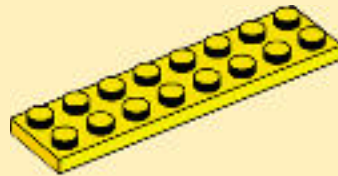



11

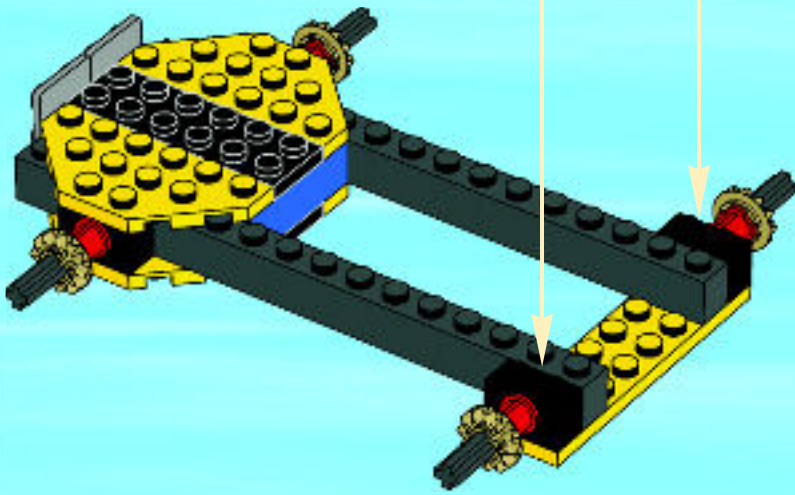
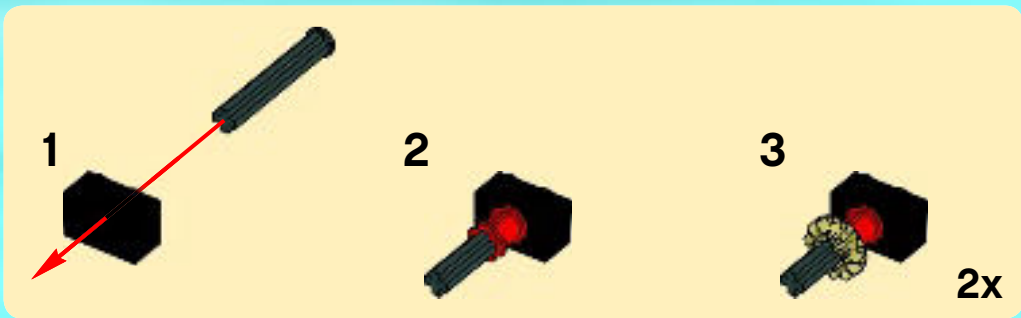



1x

12

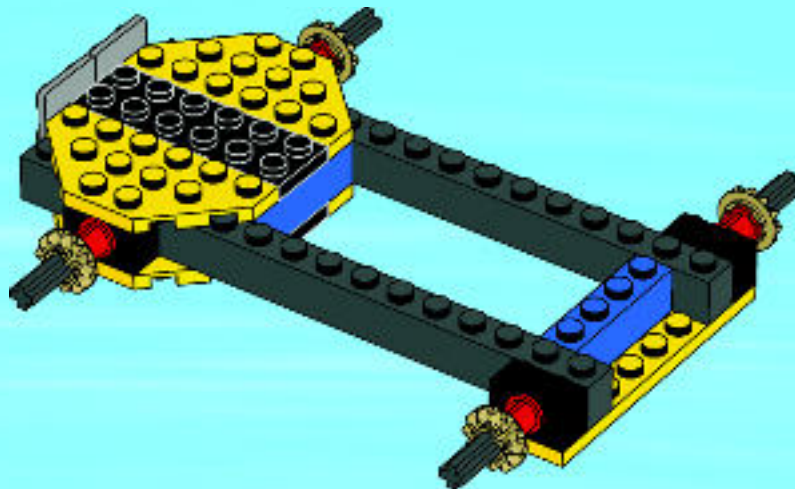

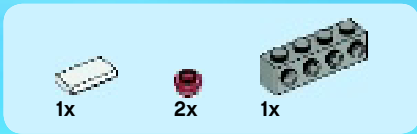

13

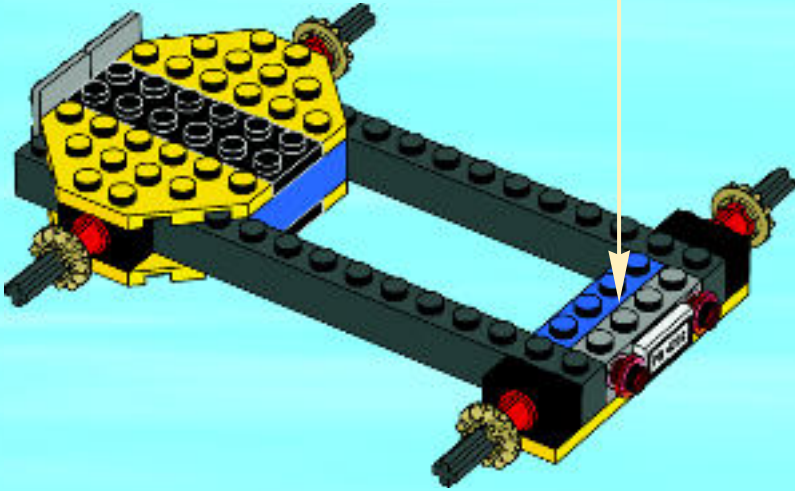
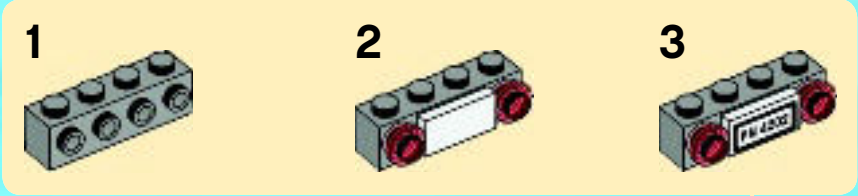

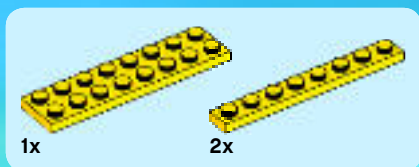

14

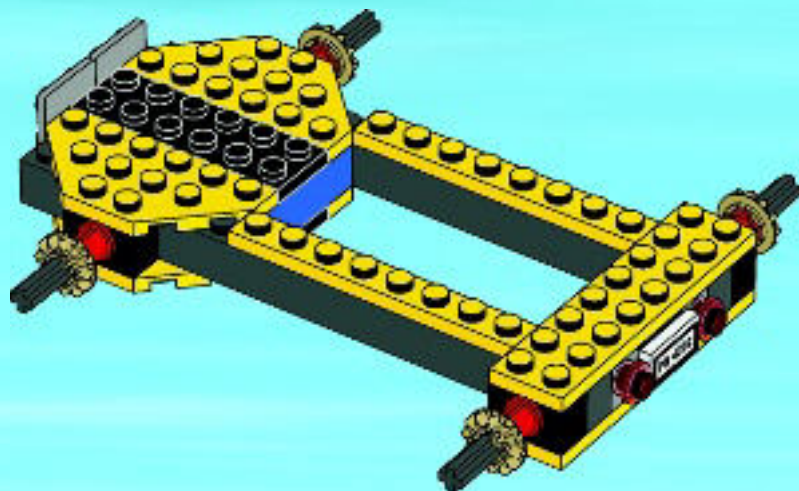



2x

15

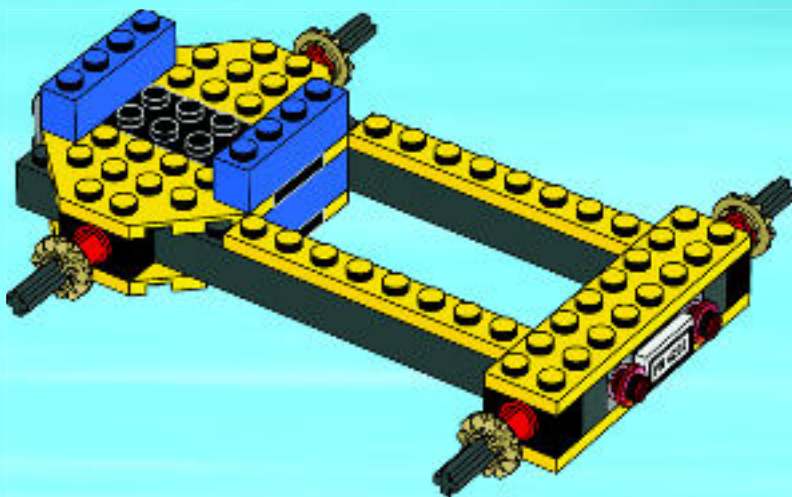



16

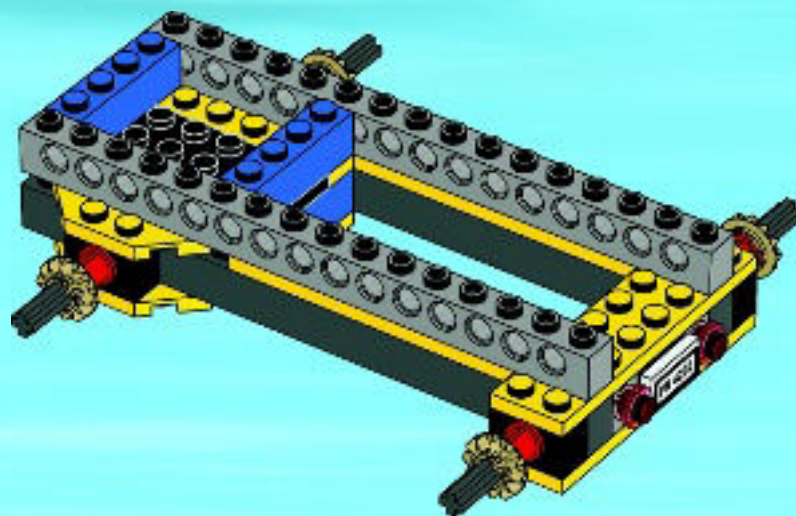



2x

17



2x

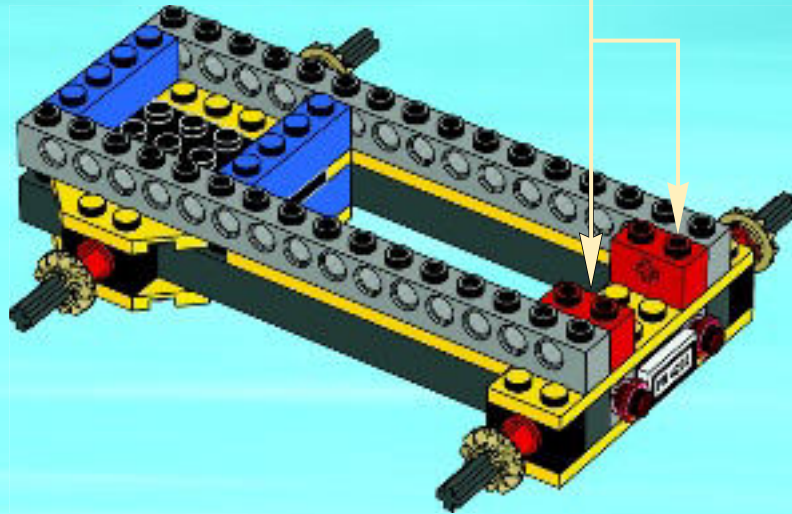



1x

18

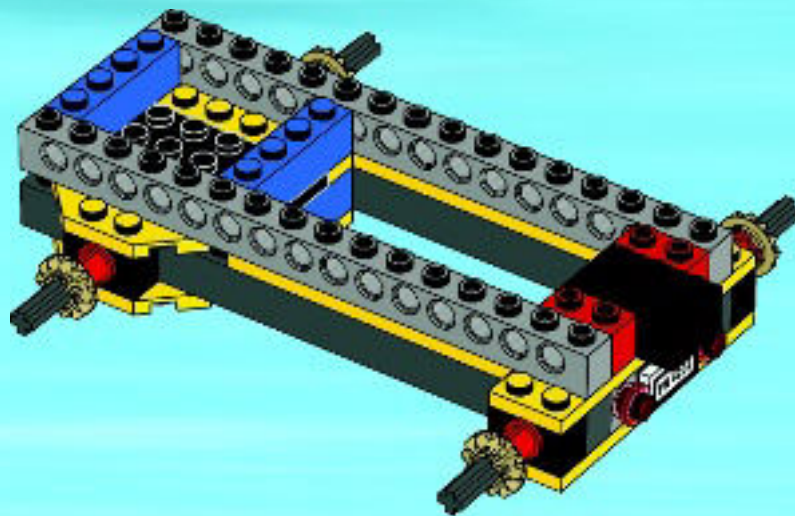

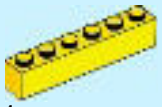

1x



2x

19

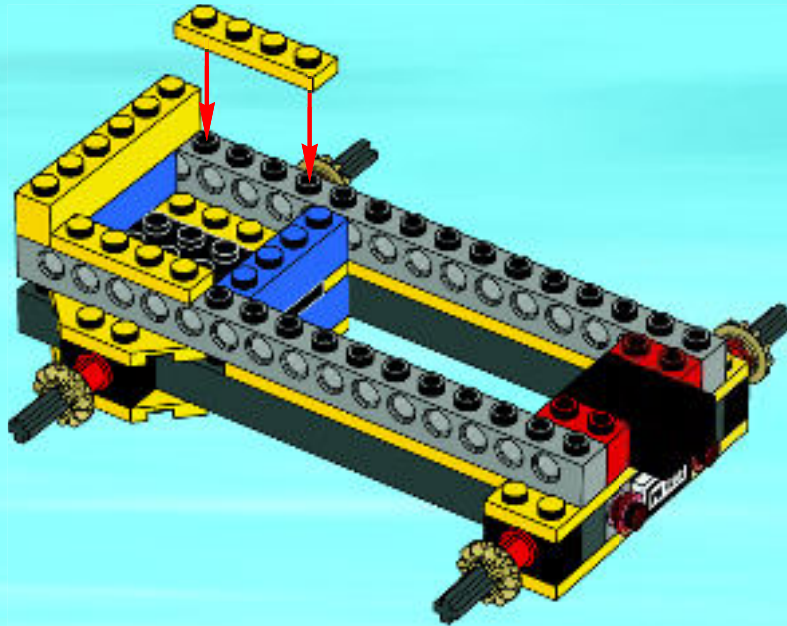



2x

20

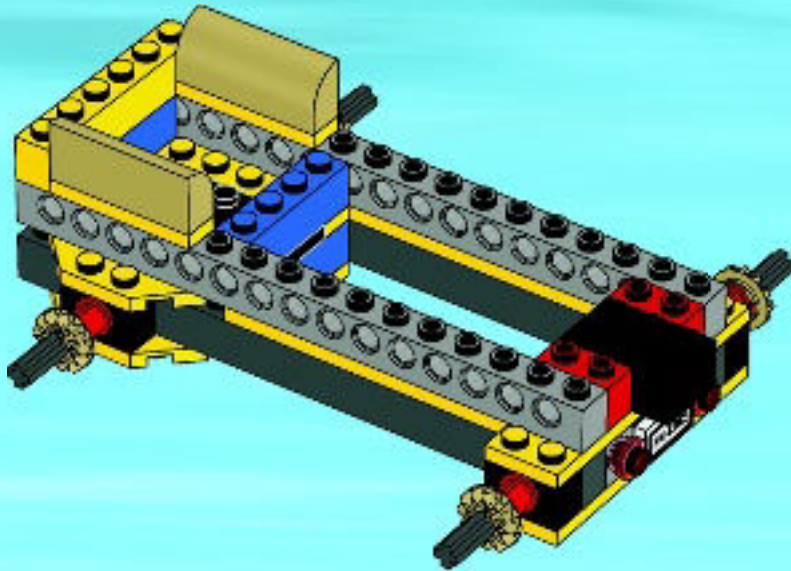



1x



2x

21

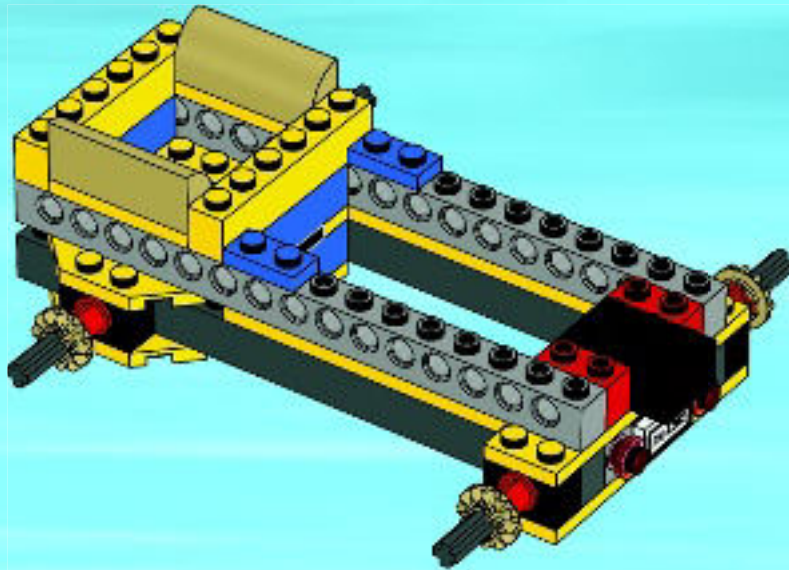



2x

22



2x

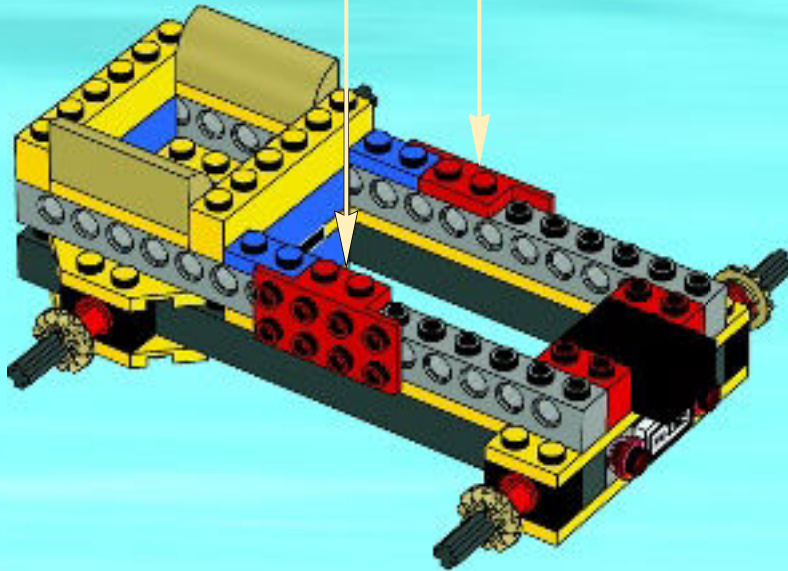



2x



1x

23

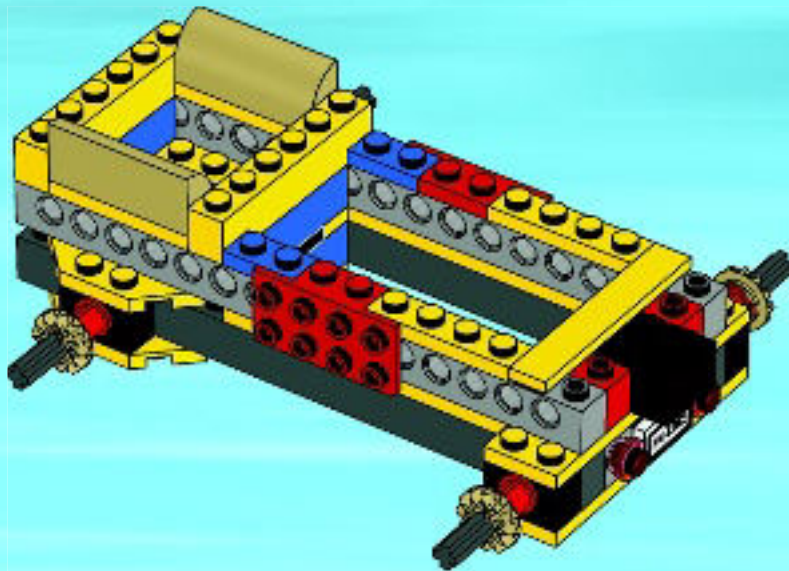



1x



1x

24

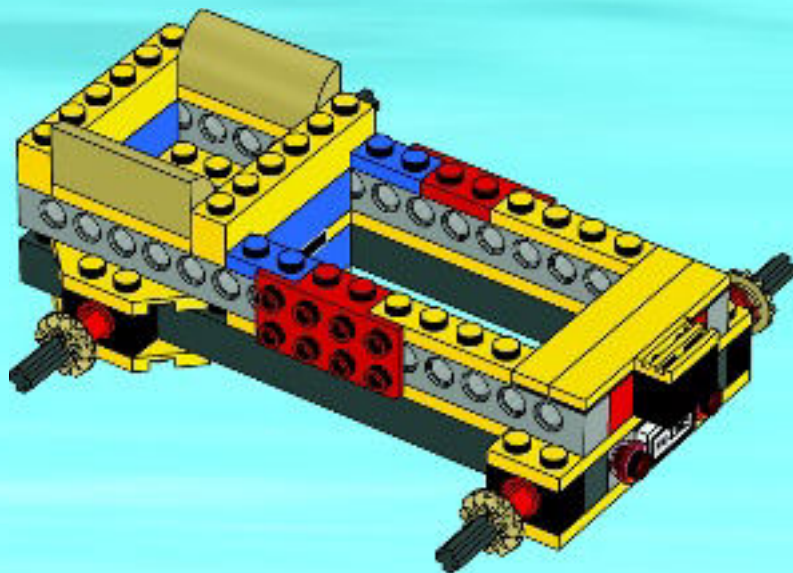



2x

25

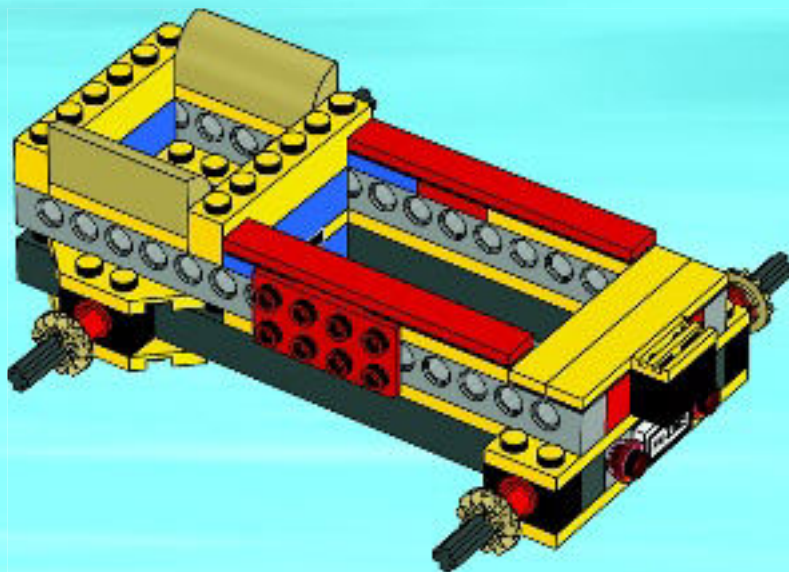



2x

26

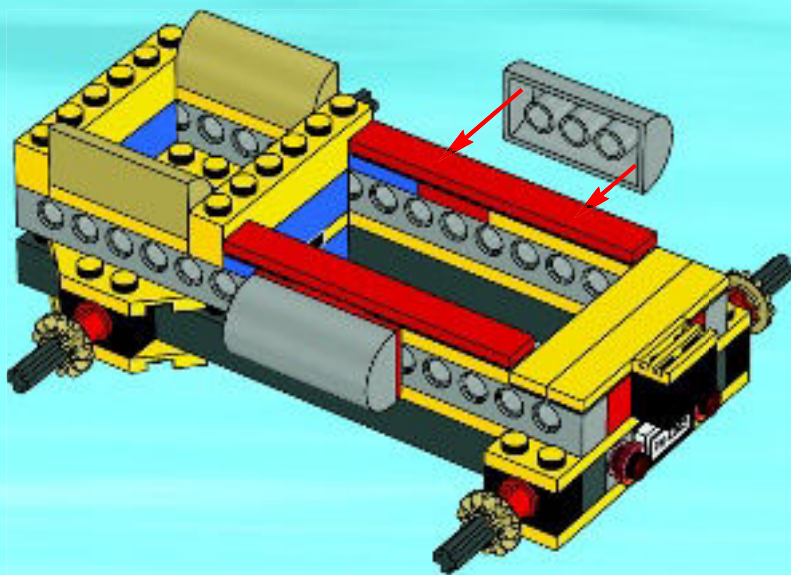



2



1x

1

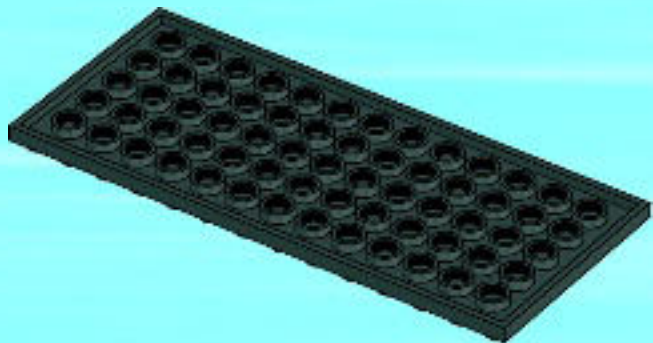

4x

2

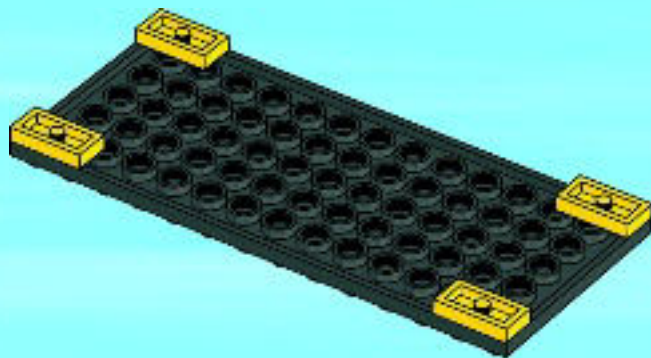



4x

3

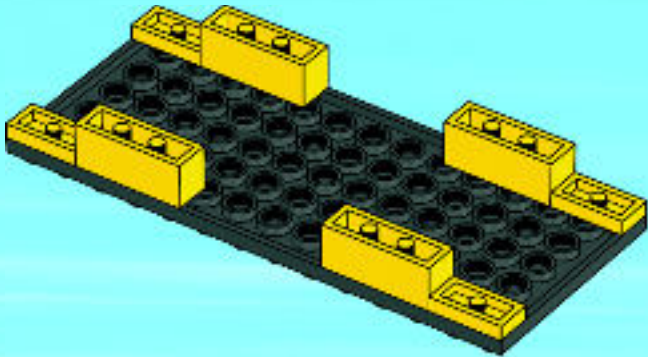

2x

4

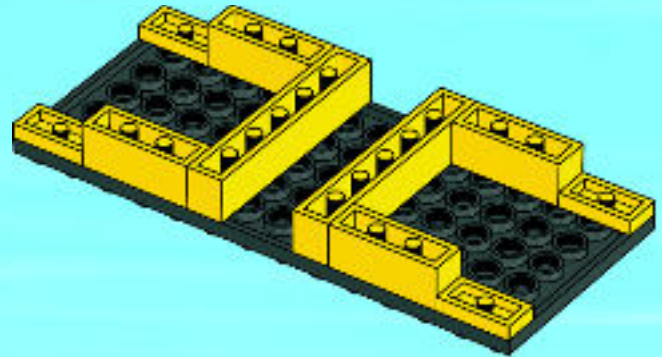



2x

5

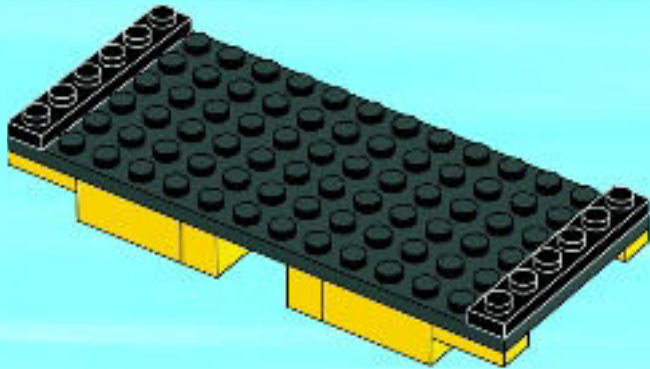

3x



2x

6

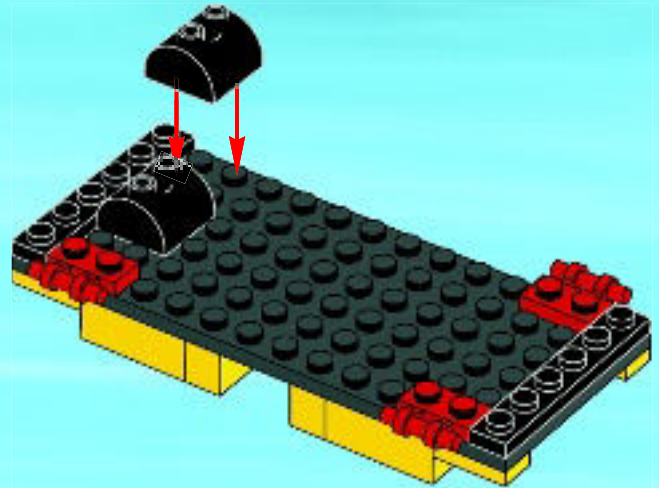



7

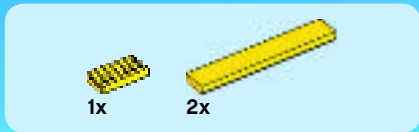
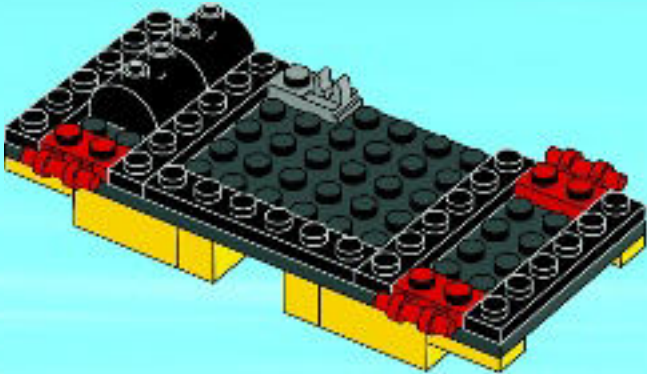

8

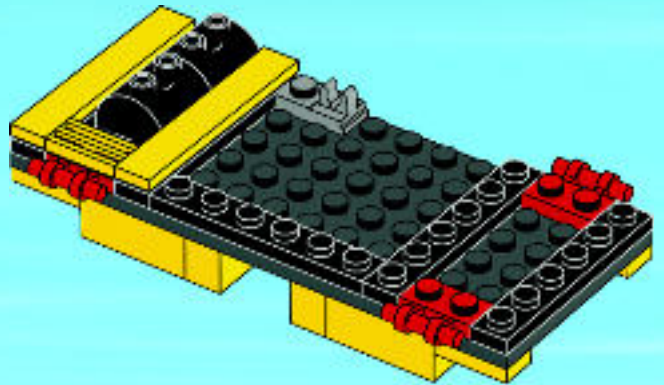



1x



1x



1x

9

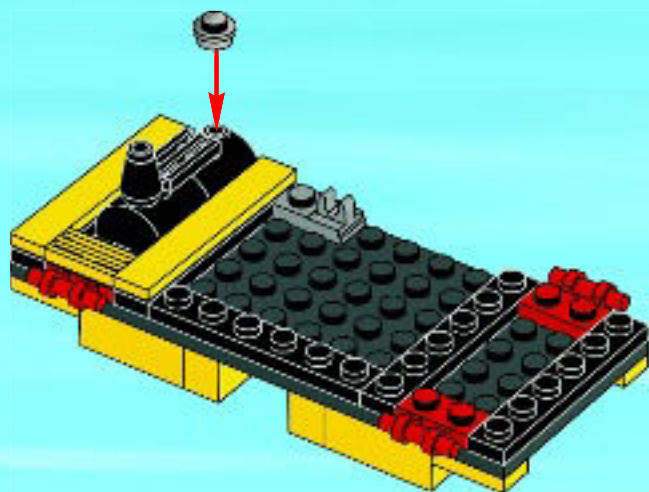

1x



2x

10

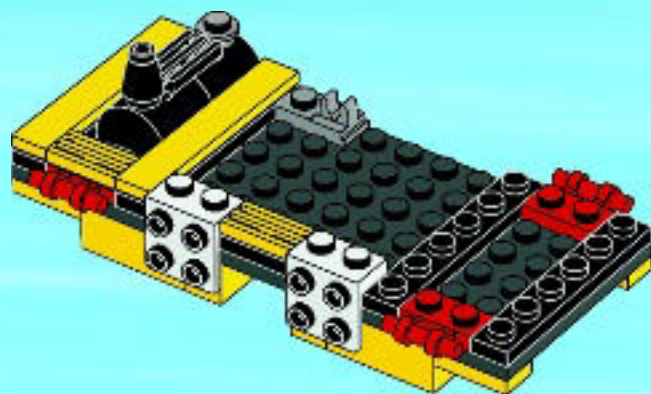



4x

11

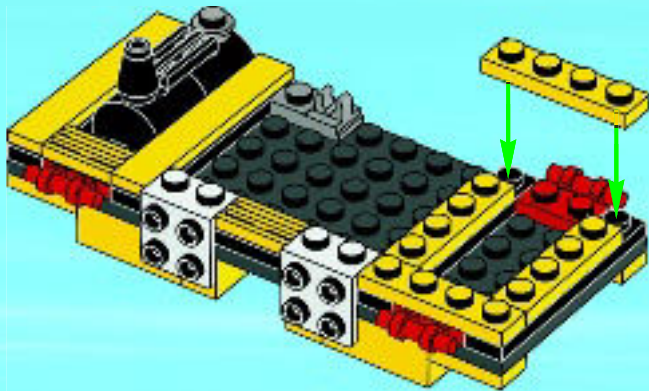

2x

12

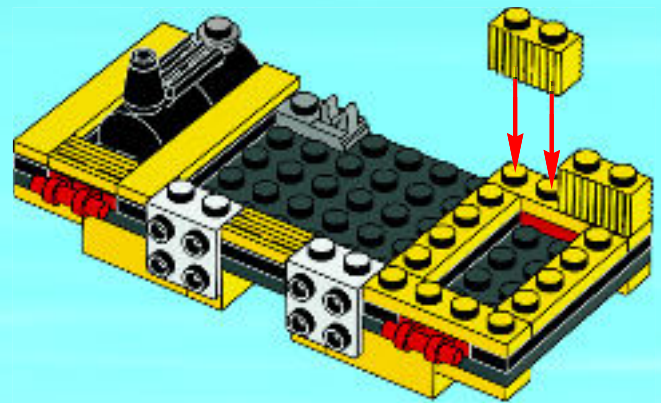



1x



1x

13

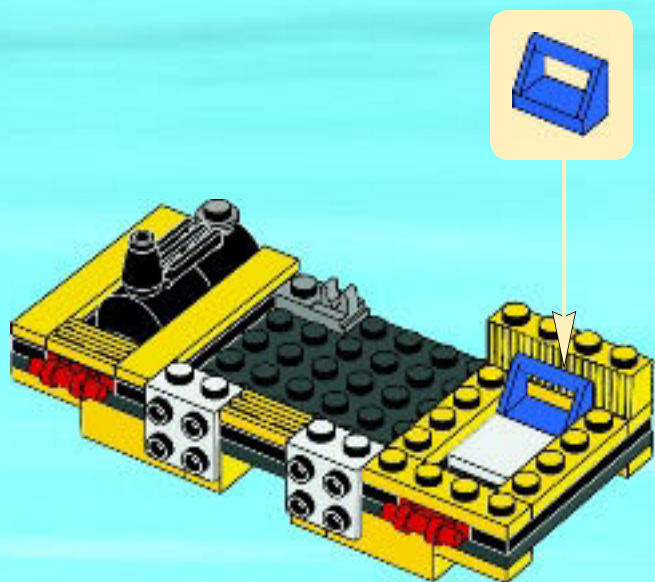

1x

14

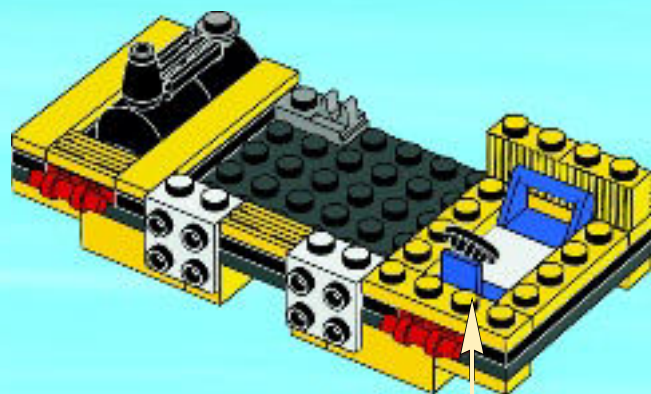

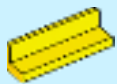

2x

15

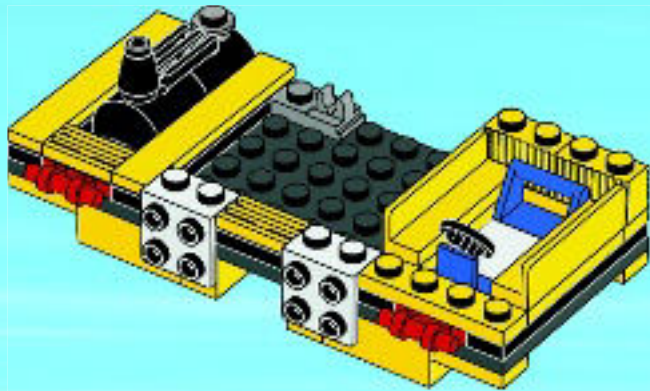

2x

16

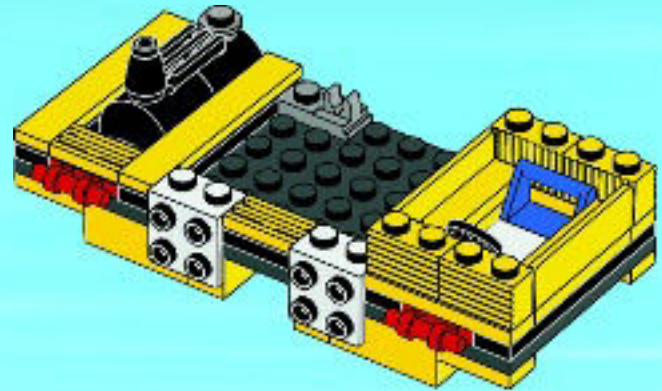



2x

17

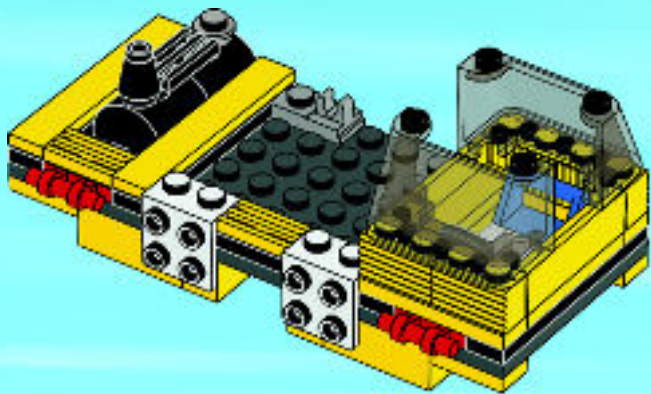

1x

18

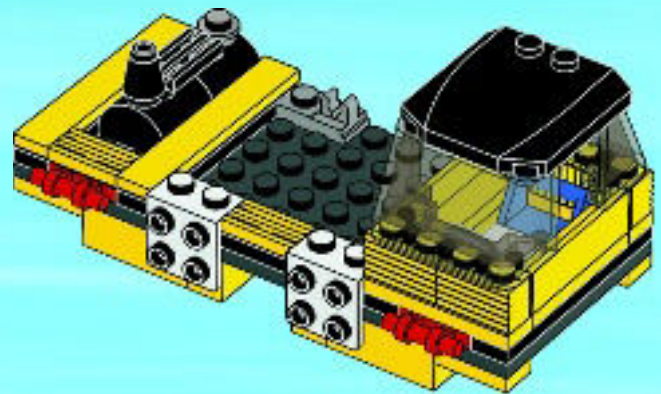

19

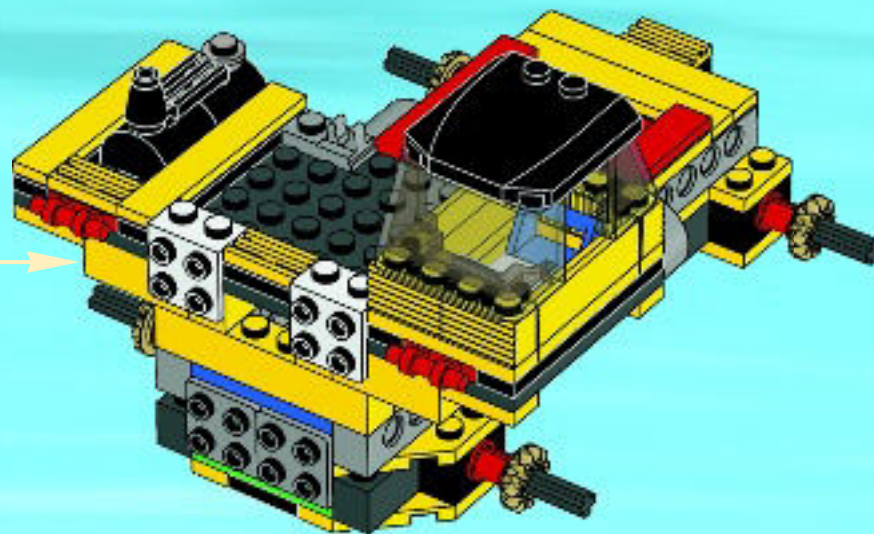

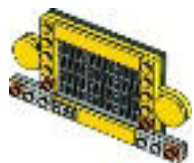

1x

1



4x

2





2x



2x

3

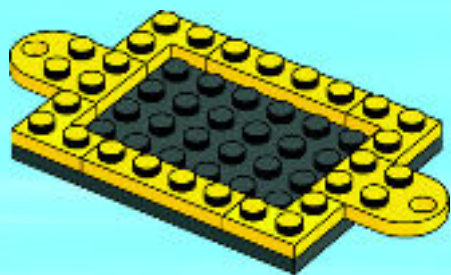

12x

4

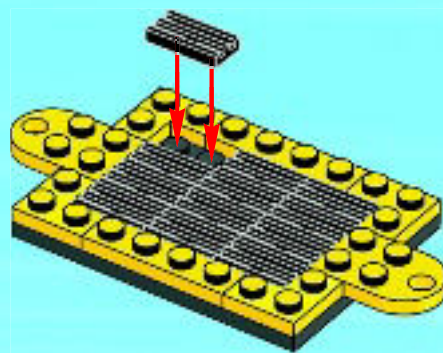



2x



1x

5

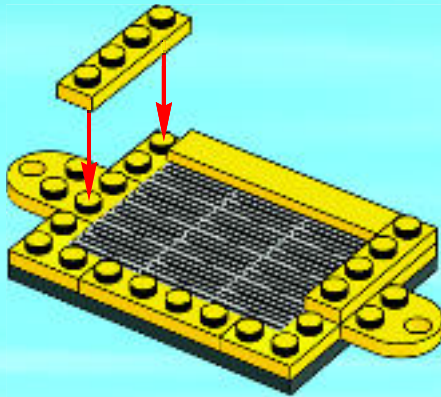

2x

6

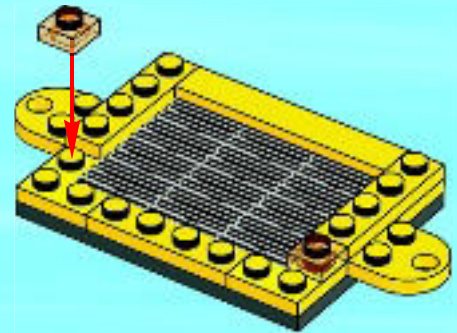

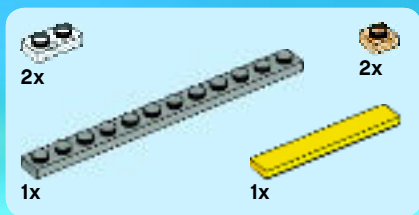

7

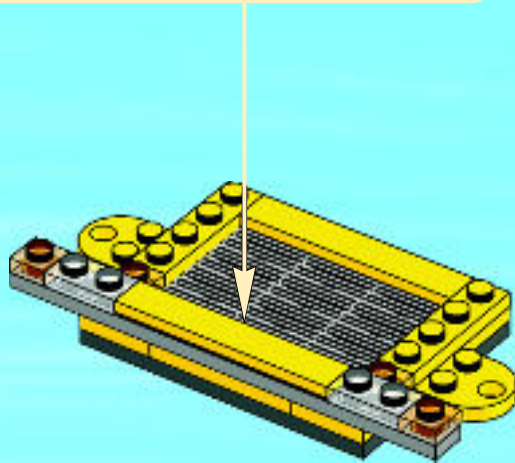
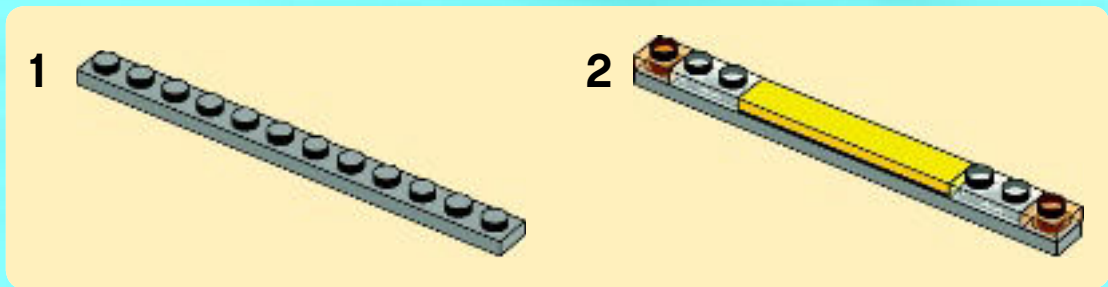



2x

8

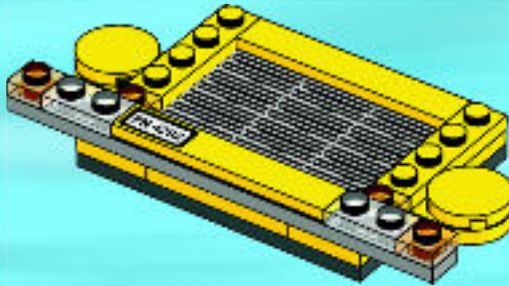

20

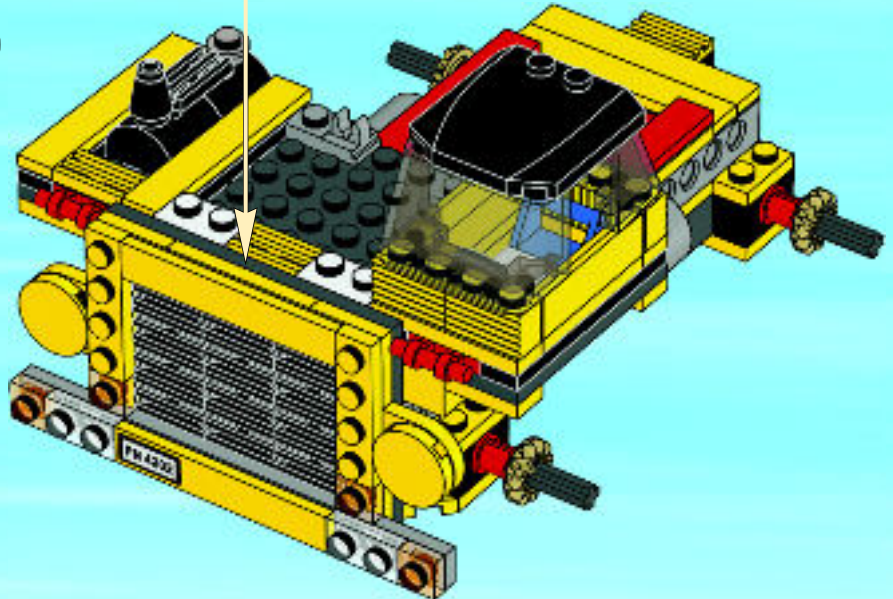

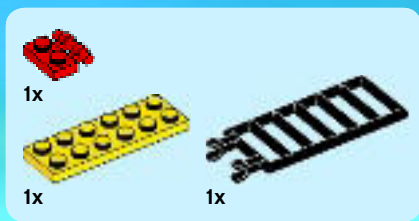

21

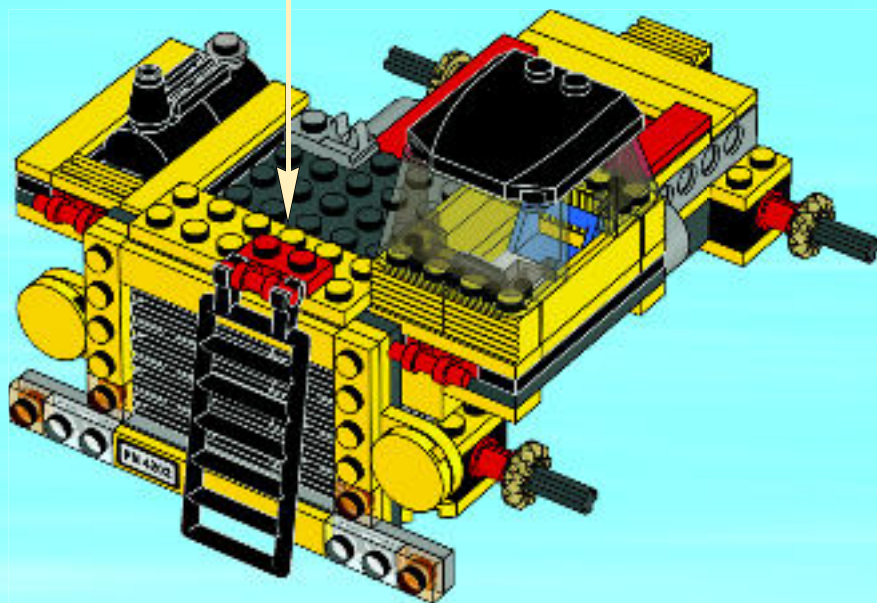
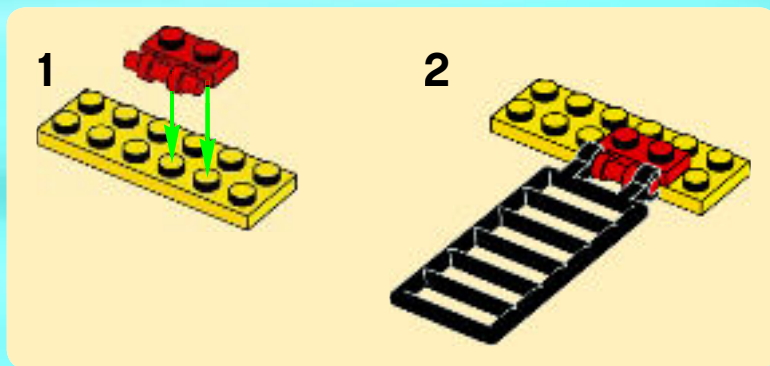

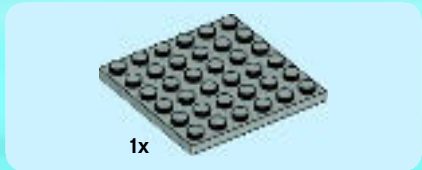
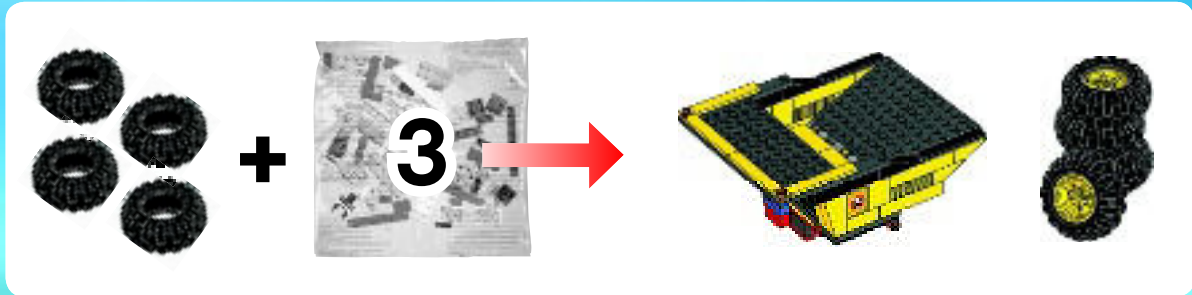

1



2

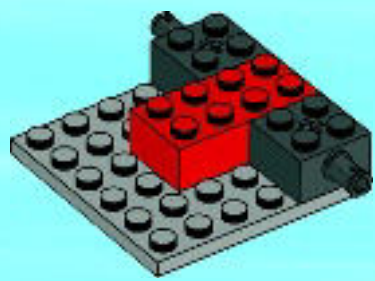



2x

3

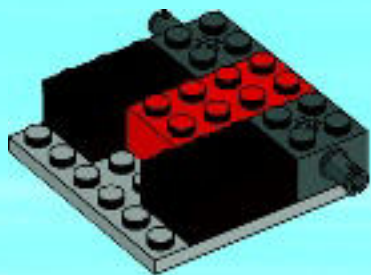

1x



1x

4

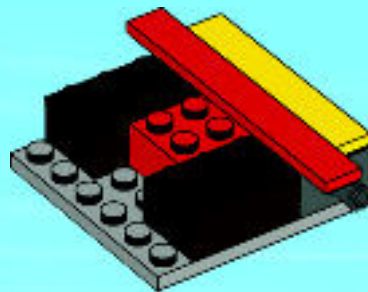



1x

5

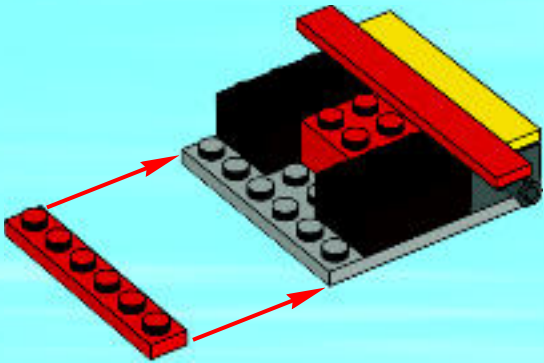

1x

6

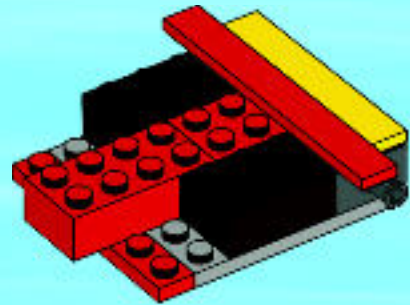



2x

7

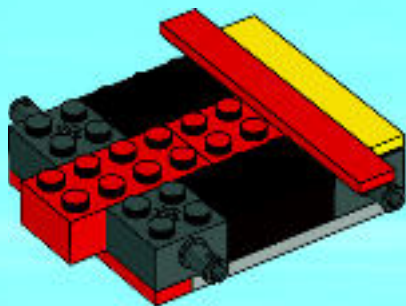

2x

8



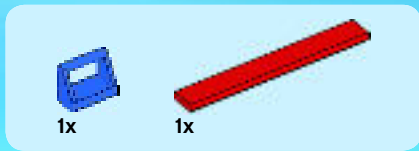

9

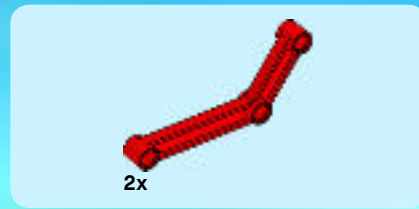
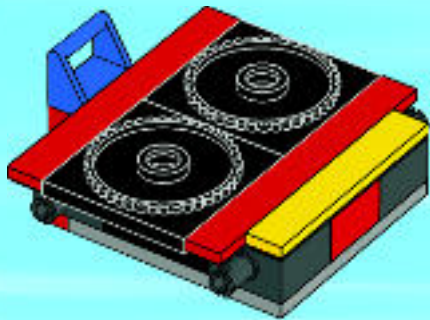

10

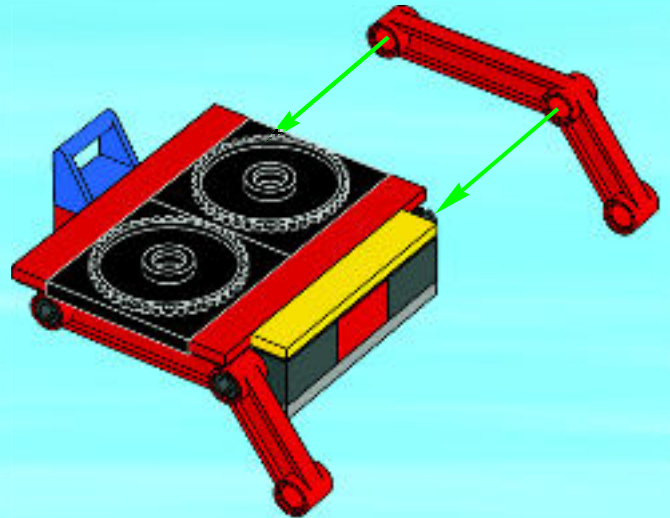



2x

22

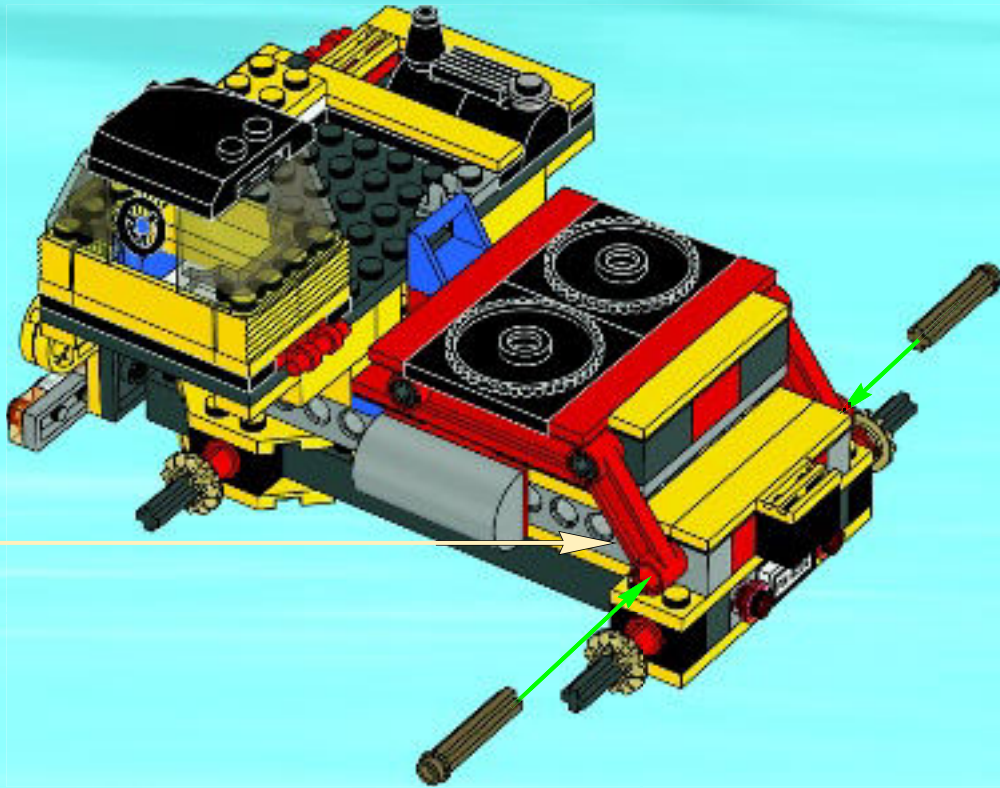



1x

1

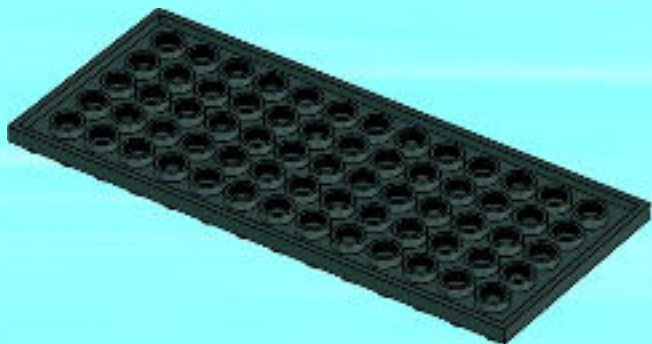

2x

2x

2

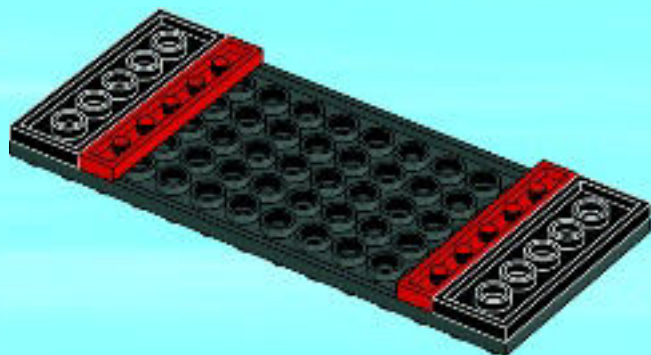



2x



2x

3

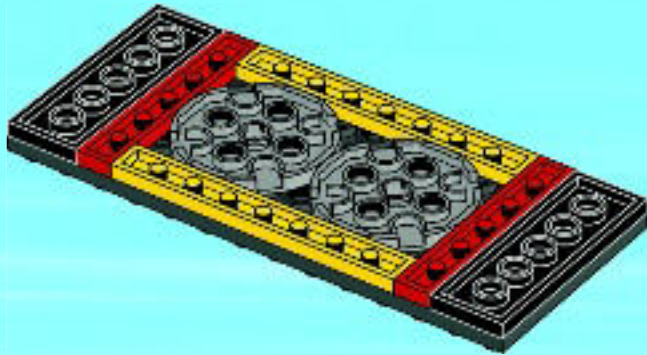

4x

4

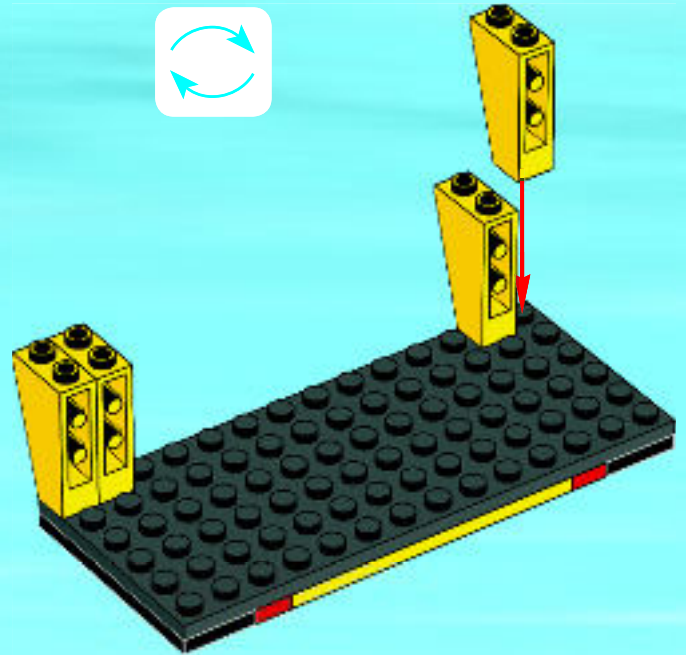



2x

5

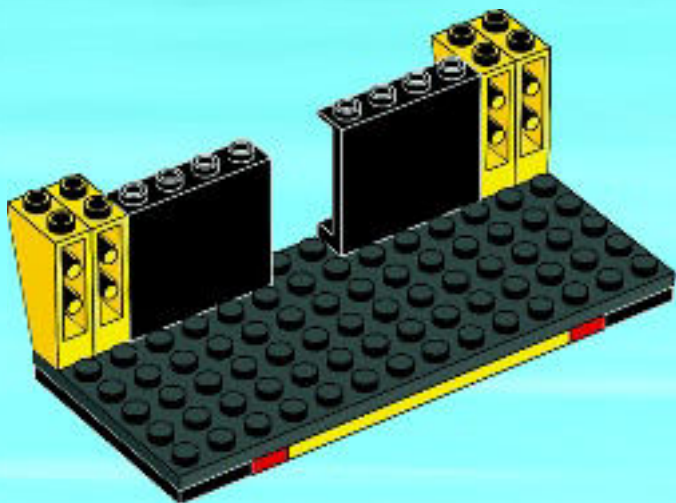

2x

6

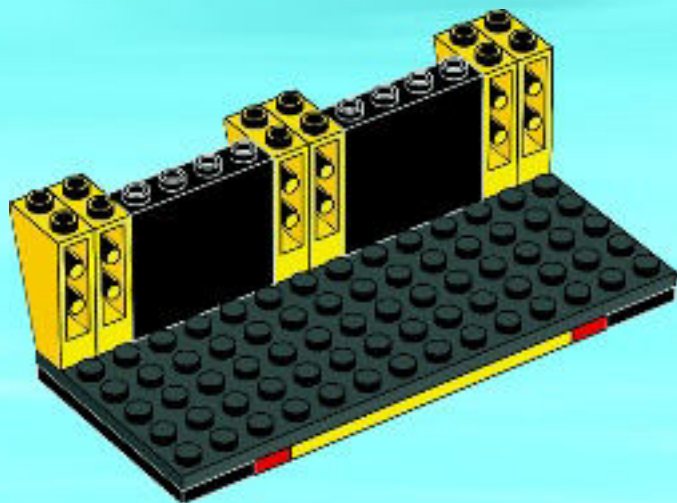



2x

7

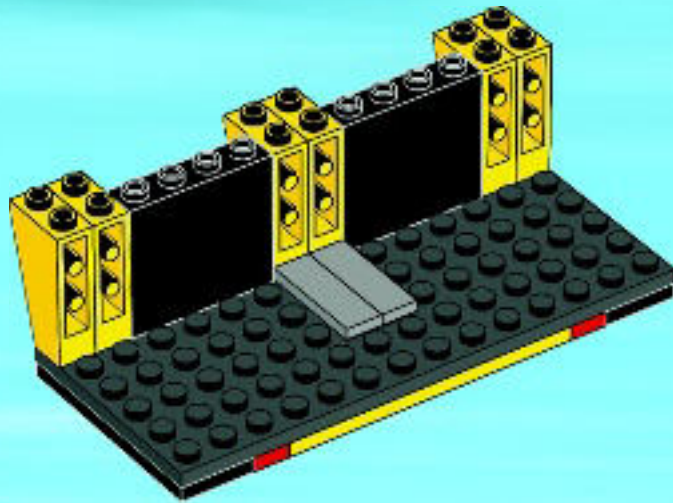



2x

8

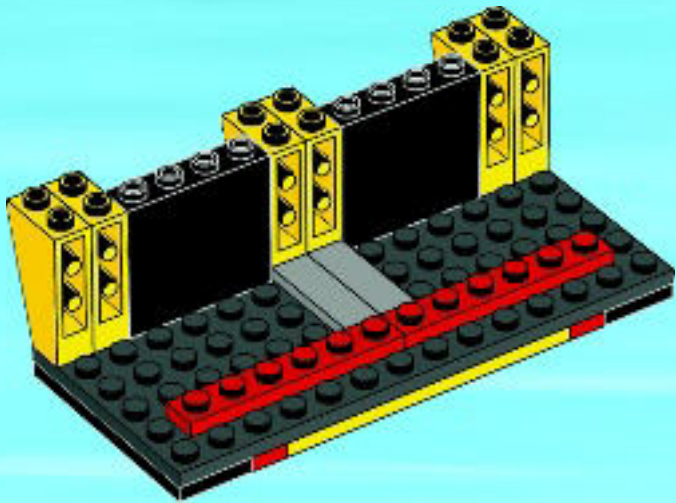

2x



4x

9

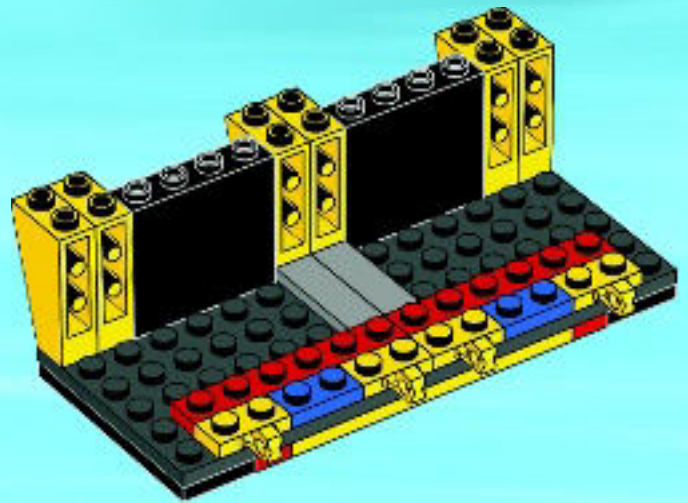

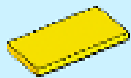

3x

10

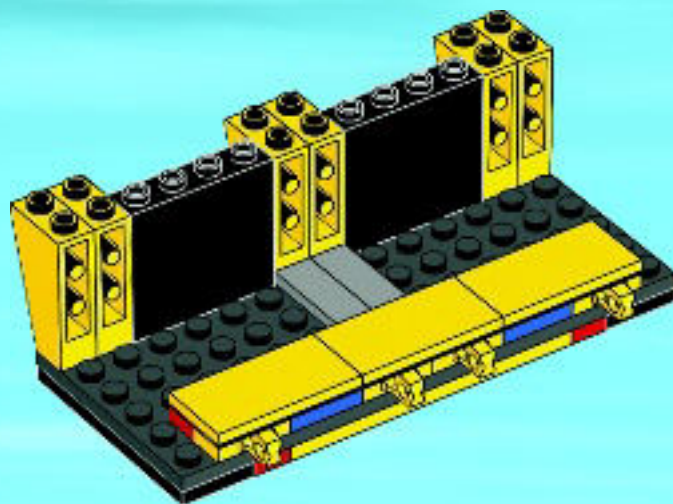

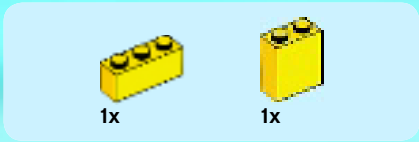

1

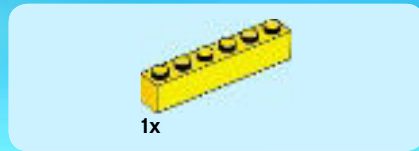
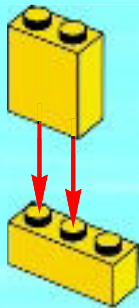

2

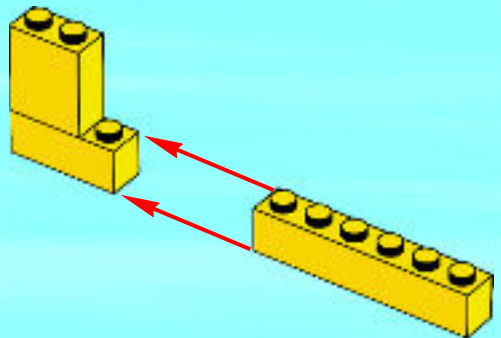



1x

3

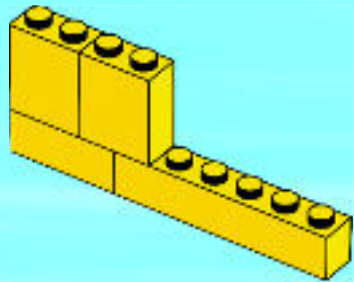

2x

4

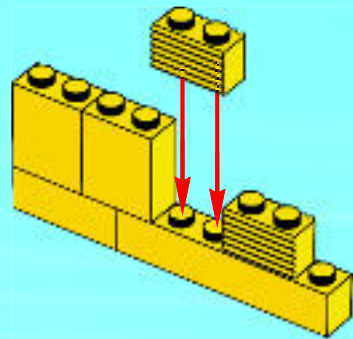



1x

5

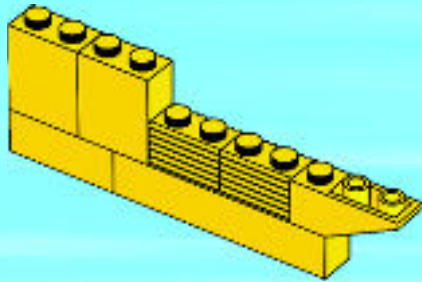

1x

6

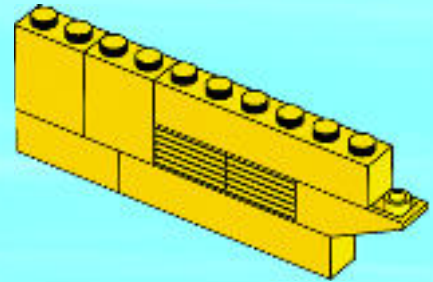



1x

7

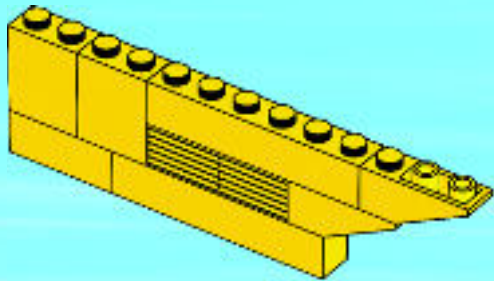

1x

8

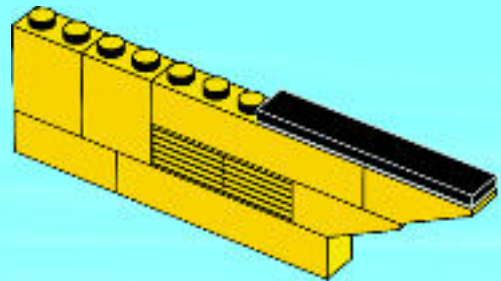



1x



1x

9

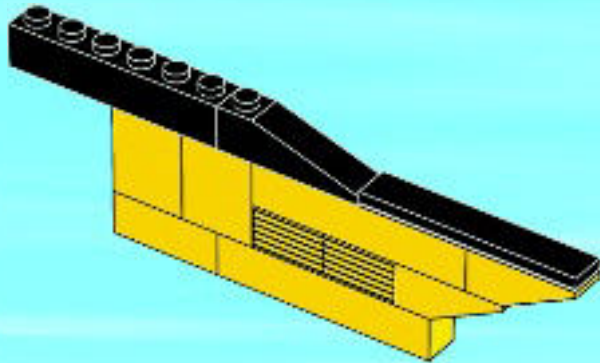

1x

10

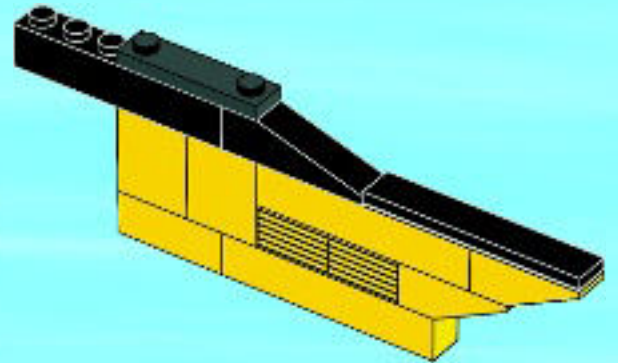

2x

11

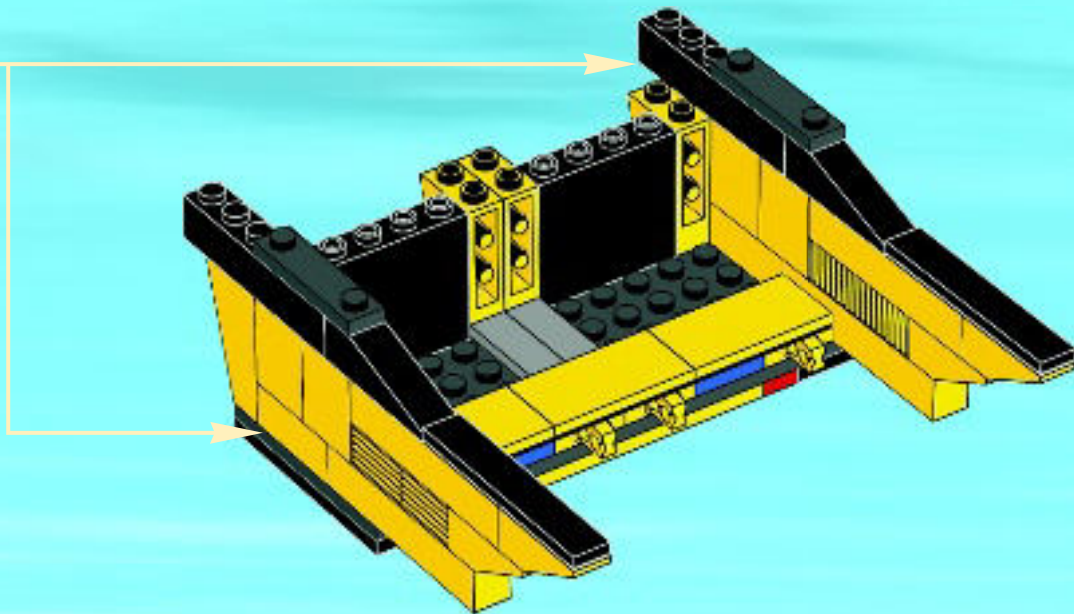



2x

12

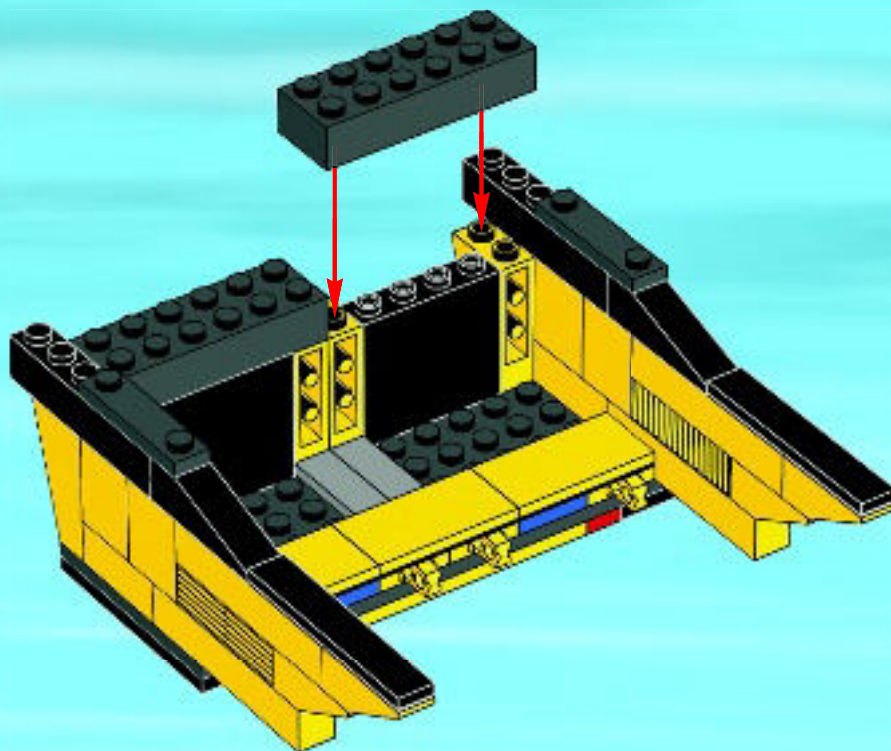



13

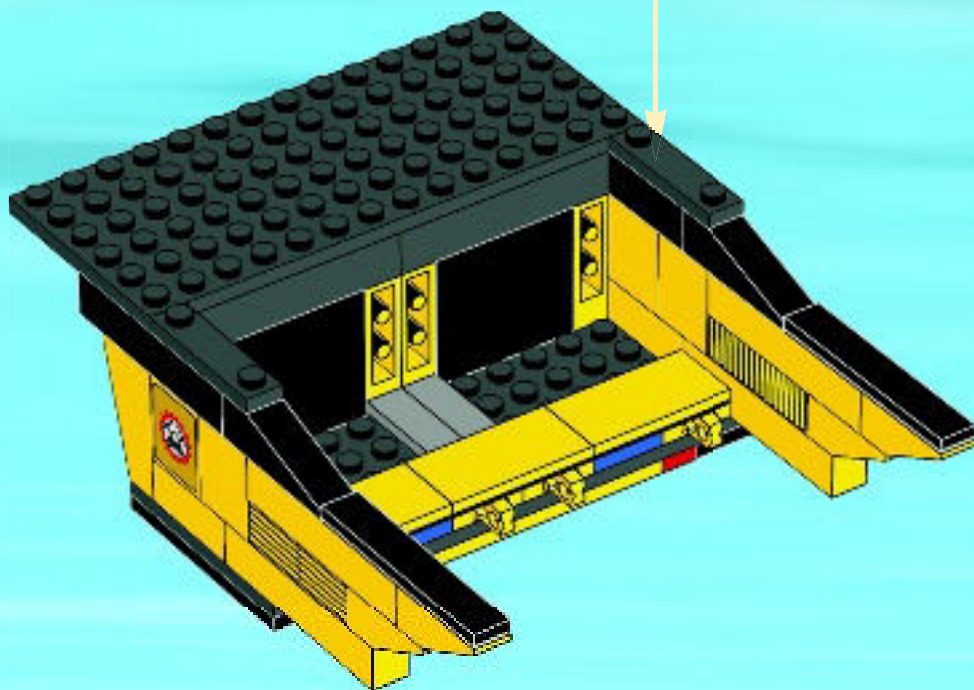



2x



2x

14

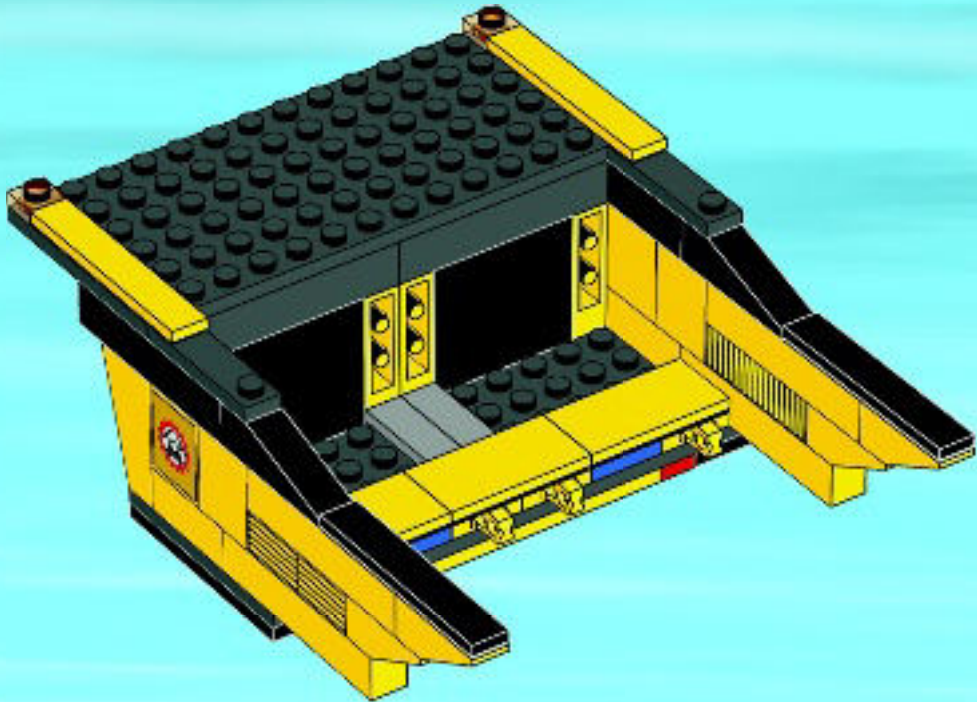



2x

15

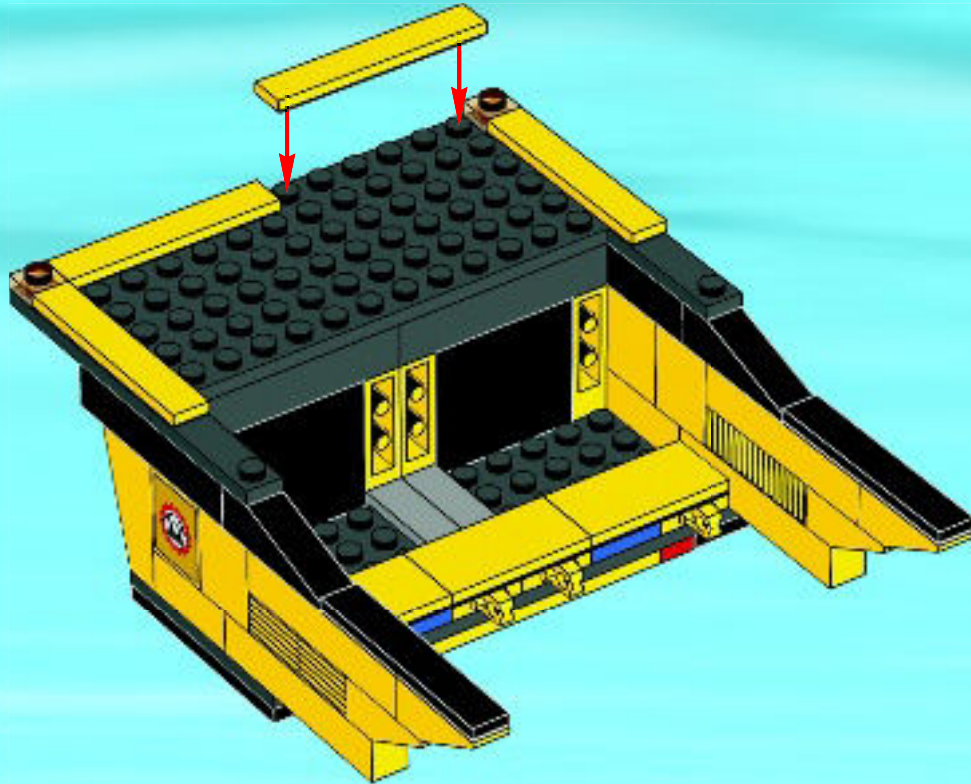

23

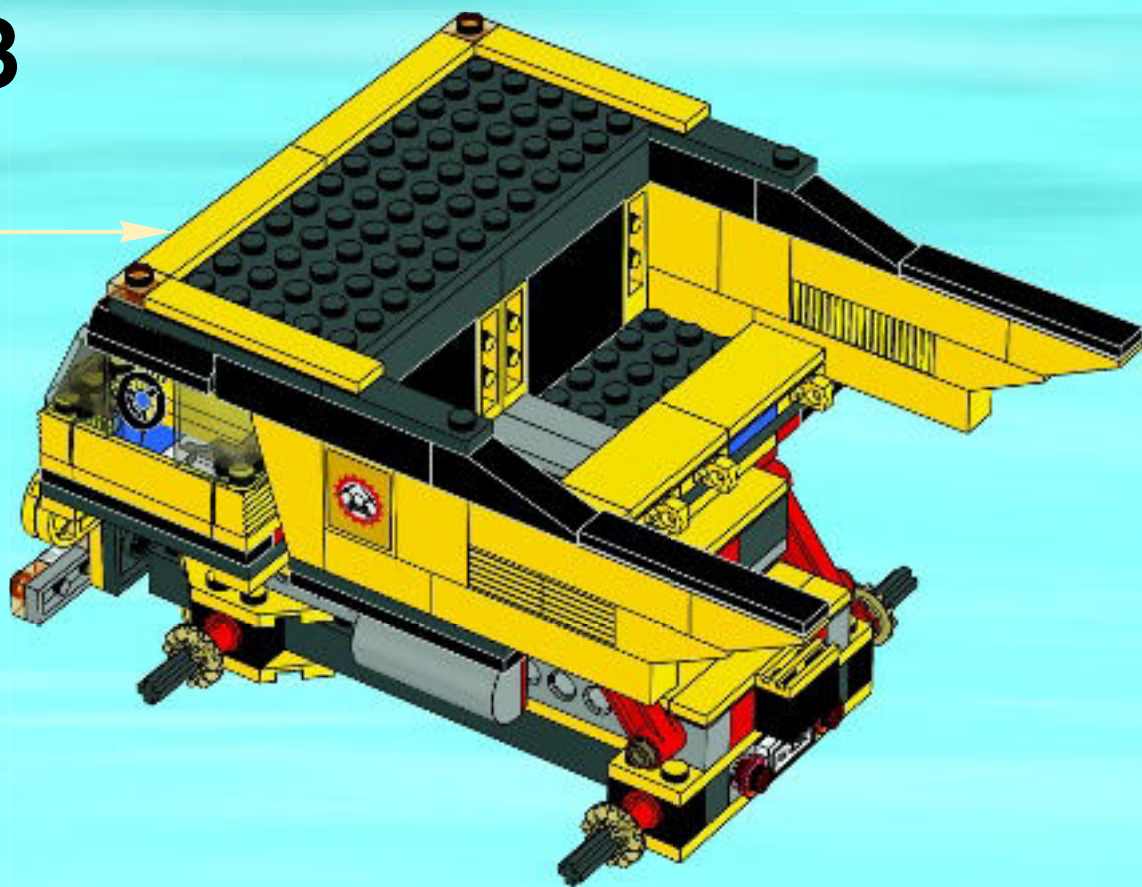

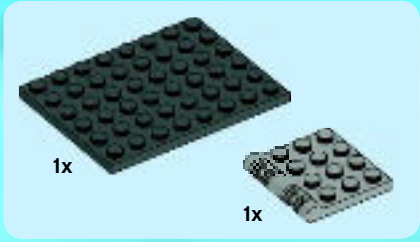

1

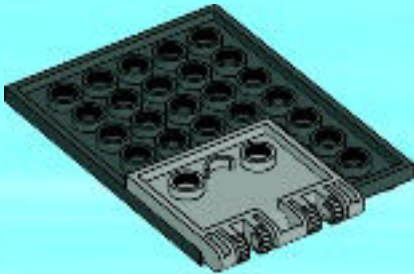

2

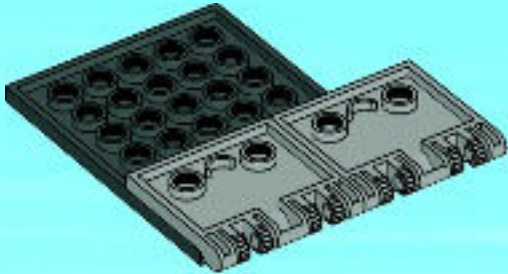



3

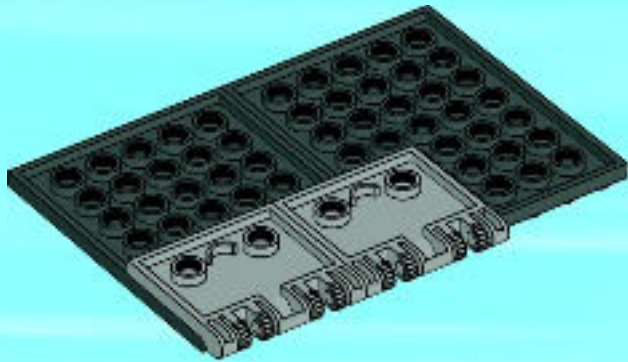

4

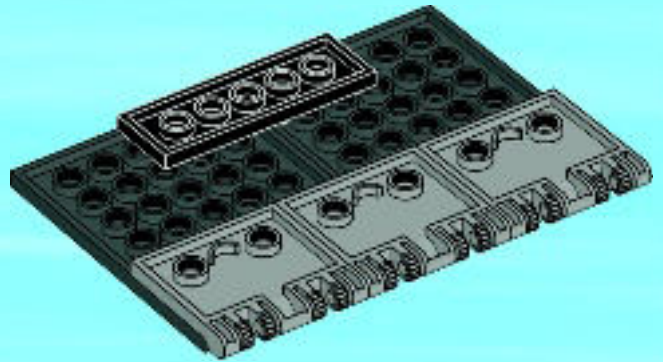

24

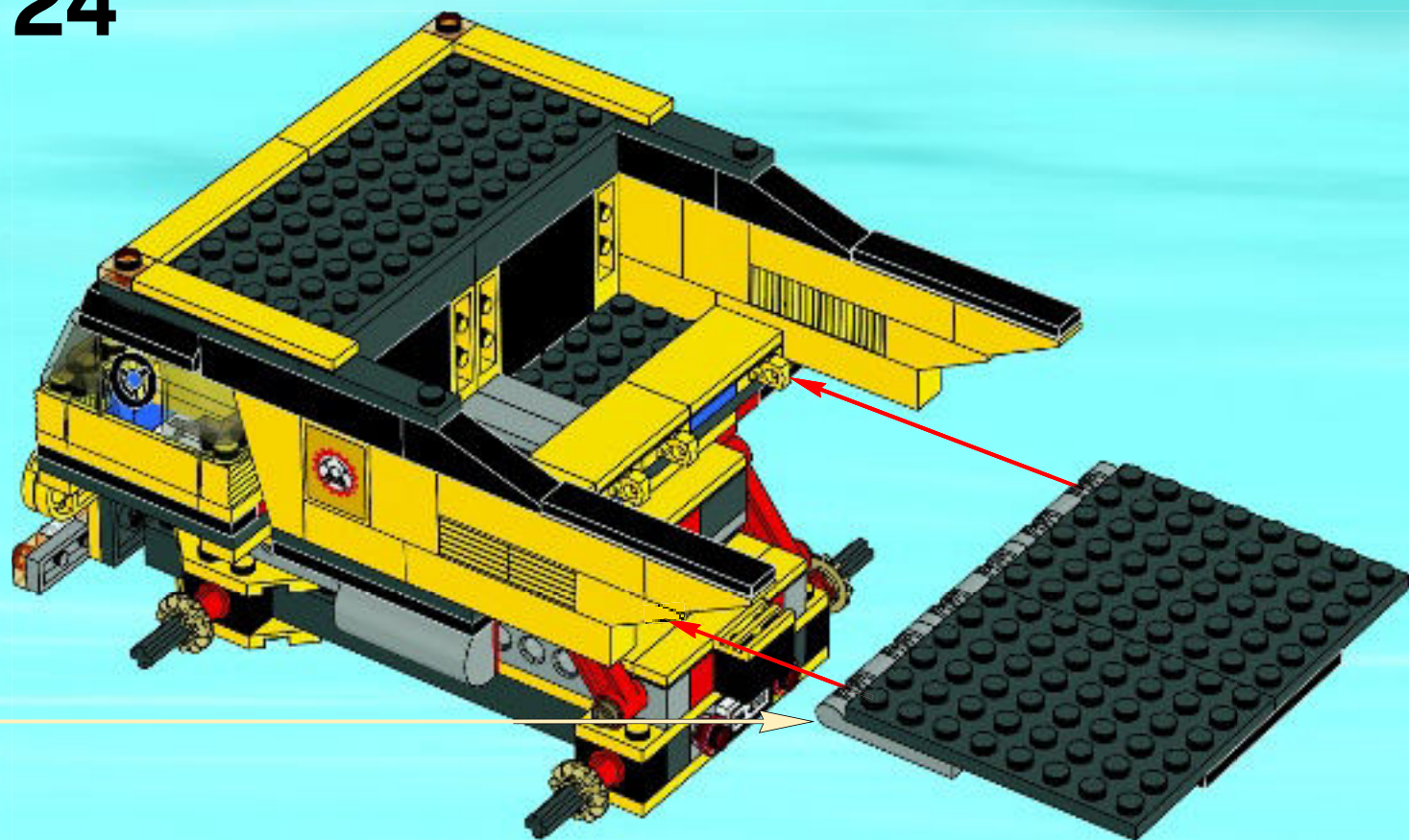

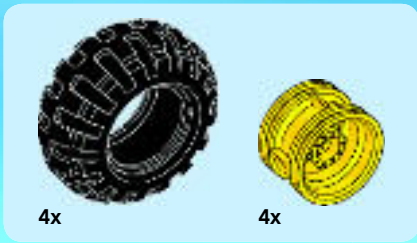

25

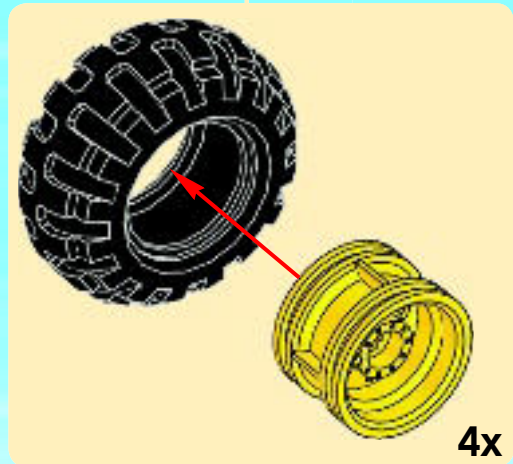

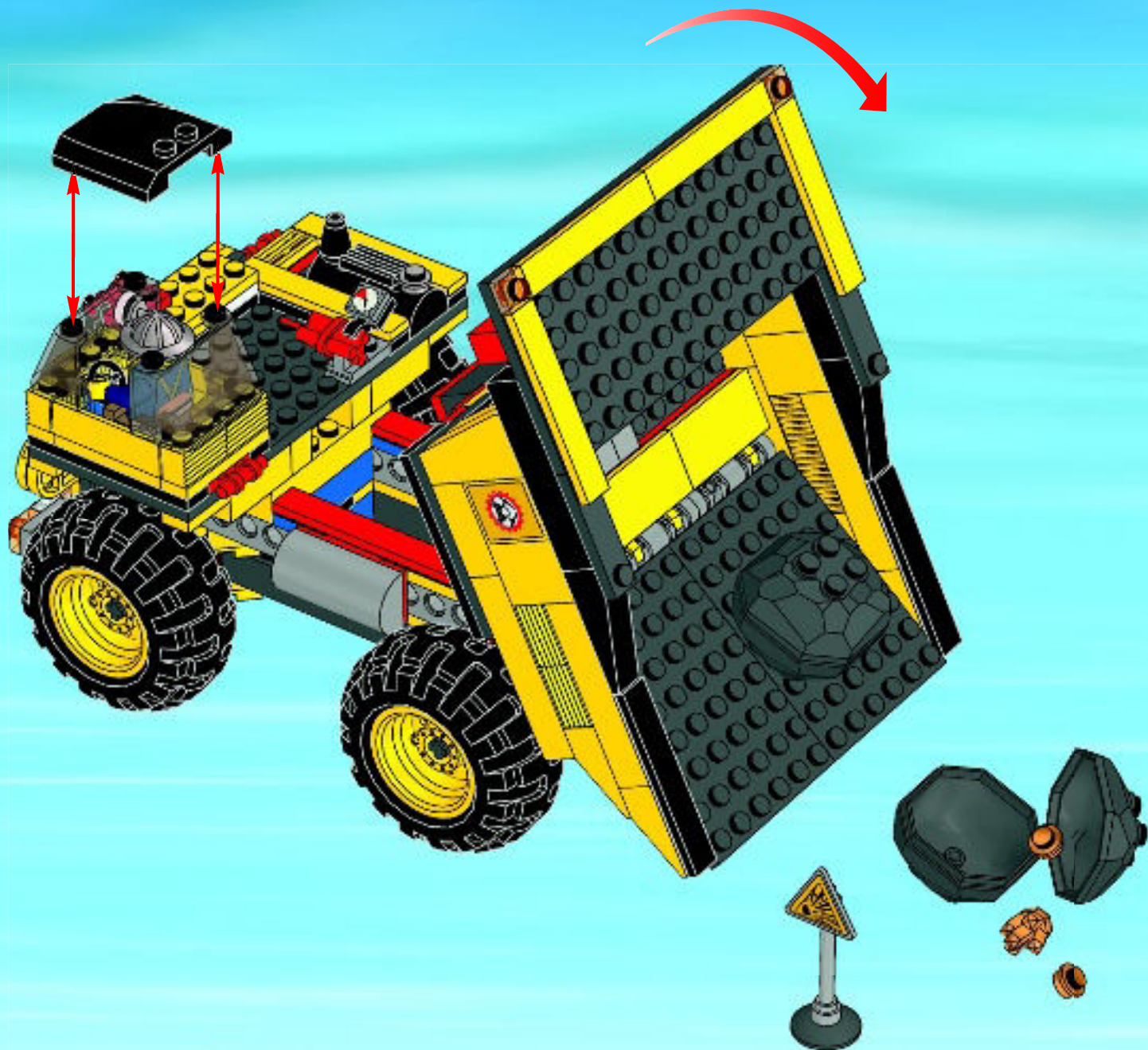



CITY



4440



4439



4441



4437



4436



CITY



videogames.LEGO.com

Exclusively on

Wii U™

NINTENDO 3DS™



www.pegi.info

Provisional Rating

LEGO CITY



4204



4203



4202



4201



4200



www.LEGOclub.com/Max

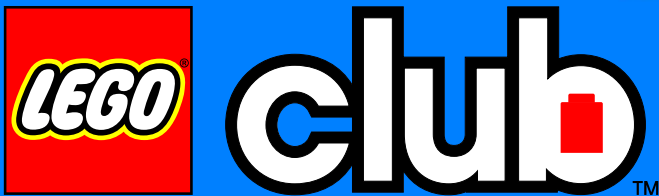

FREE*! GRATIS! GRATUIT!

*Paid subscription in Australia and New Zealand.
*Abonnement payant en Australie et Nouvelle-Zélande.

©2012 The LEGO Group.



Customer Service
Kundenservice
Service Consommateurs
Servicio Al Consumidor

www.lego.com/service or dial



: 00800 5346 5555
 : 1-800-422-5346



WIN!

Go to www.LEGOsurvey.com/product to fill out a survey for a chance to win a cool LEGO® Product.

No purchase necessary.

Open to all residents where not prohibited.

 www.LEGO.com



www.LEGOsurvey.com/product

GEWINNE! WIN!

Nimm an der Umfrage auf www.LEGOsurvey.com/product teil und hab die Chance ein cooles LEGO® Produkt zu gewinnen!

Die Teilnahme am Gewinnspiel führt zu keinerlei Kaufverpflichtungen. Teilnahme in allen nicht ausgeschlossenen Ländern möglich.

Ga naar www.LEGOsurvey.com/product, vul een enquêteformulier in en maak kans op een cool LEGO® product.

Geen aankoopverplichting. Iedereen mag deelnemen, uitgezonderd ingezetenden van landen waar een enquêteverbod geldt.

GAGNE! 当てよう!

Visite www.LEGOsurvey.com/product pour répondre à un questionnaire et avoir une chance de gagner un produit LEGO® très cool!

Aucune obligation d'achat. Ouvert à tous les résidents des pays autorisés.

www.LEGOsurvey.com/product にアクセスして、アンケートにご記入ください。当選者にはレゴ®製品を差し上げます。

お買い上げの必要はありません。

禁止されていない限り、すべての皆様にご利用いただけます。