



CITY

4200



1

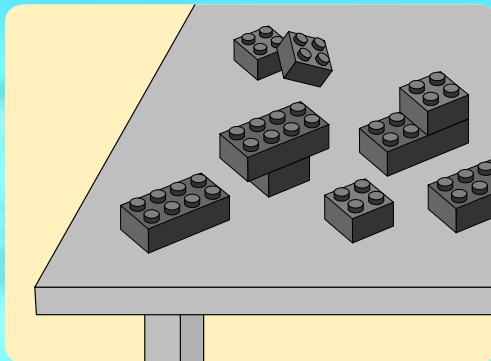
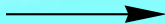
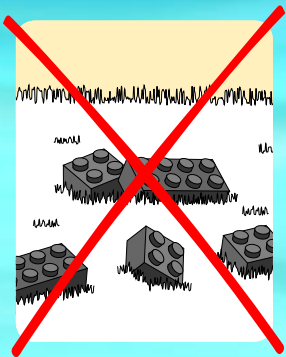

2

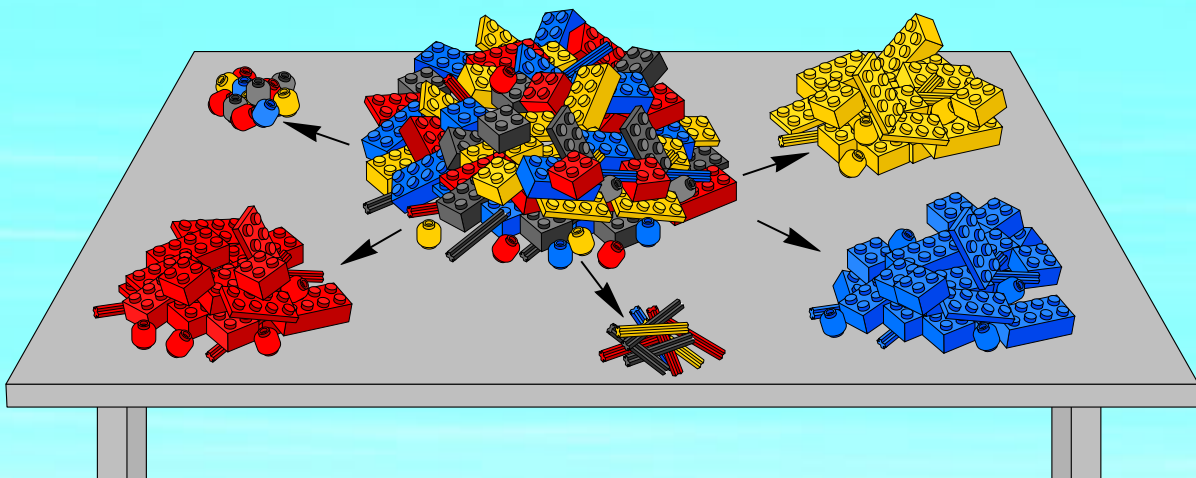



1

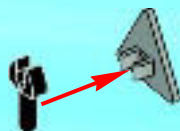

2



3



1



2



3



1



2



1

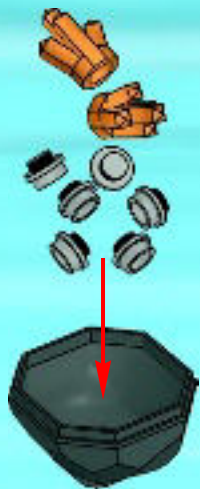

2

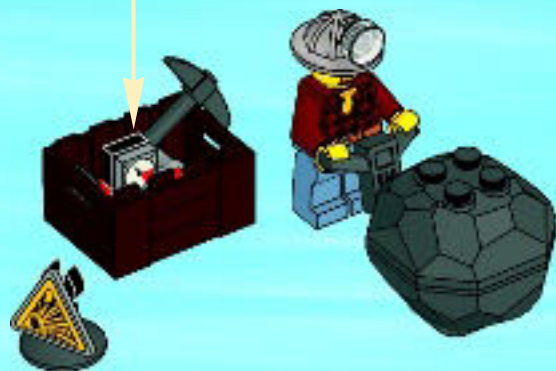



1

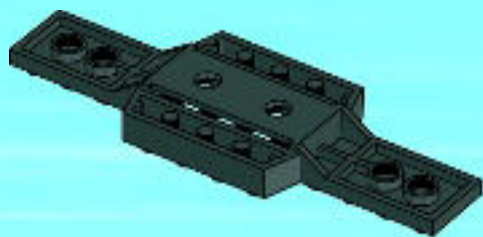

2

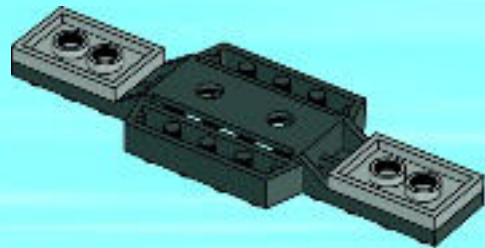

3

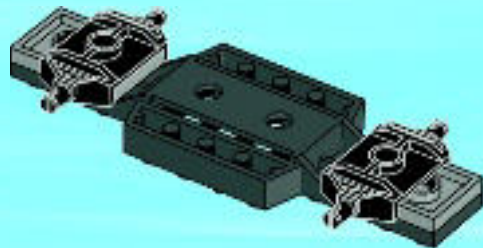



4

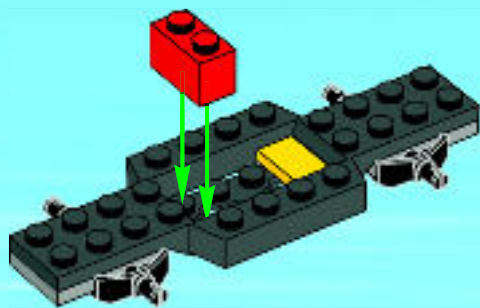

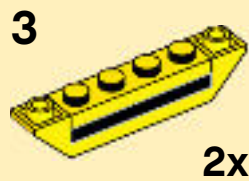

6

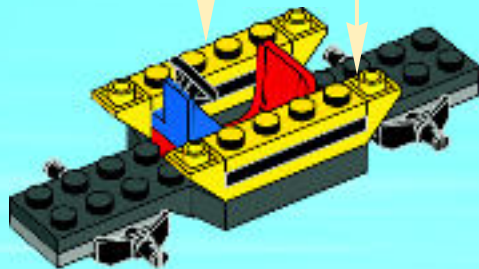

7

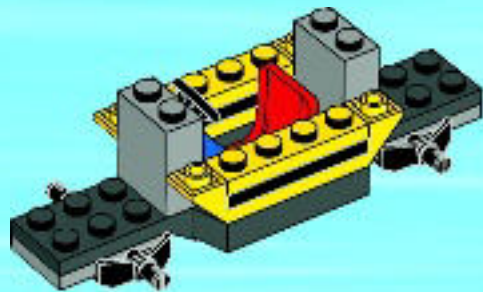

8

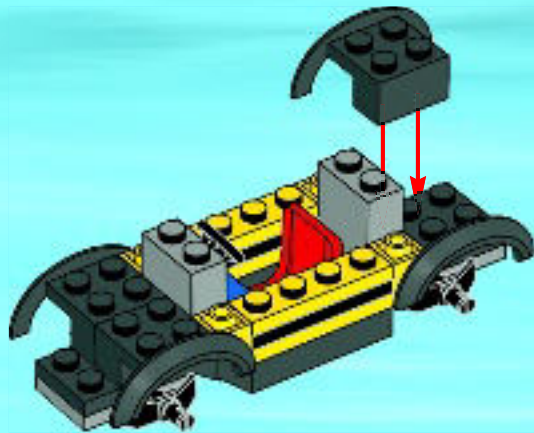

1



2



3



4

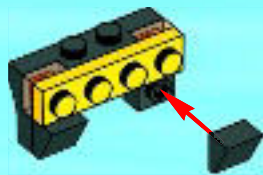

5



6



9

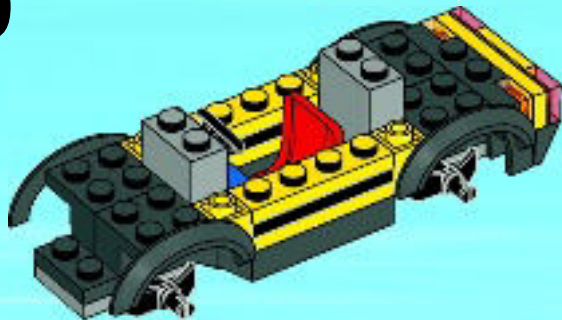

10

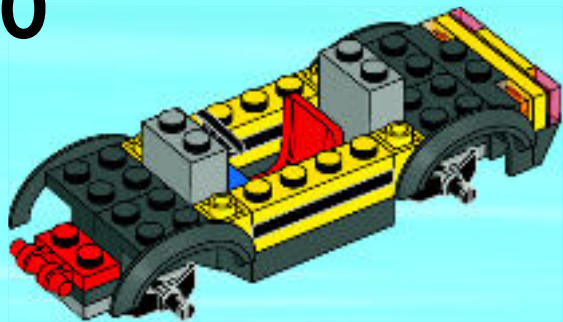

11

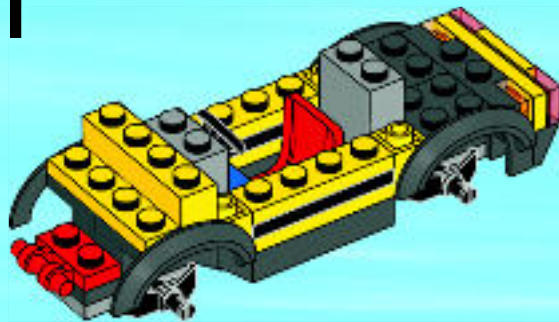

1

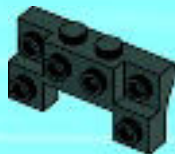

2



3



12

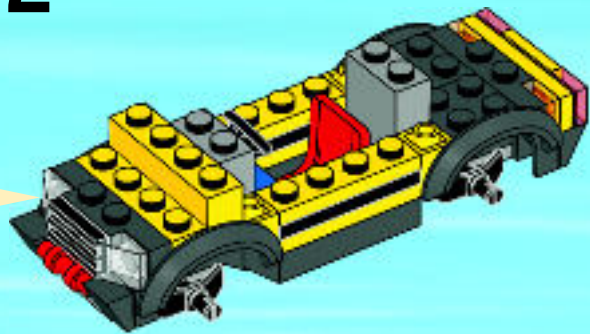

13

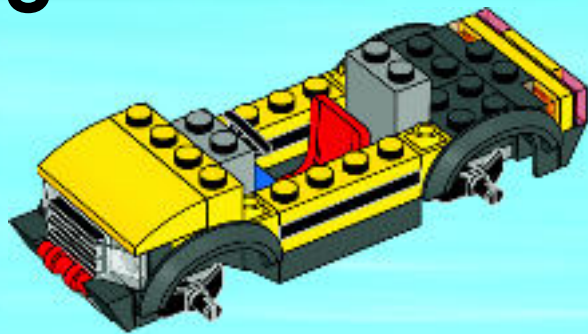

14

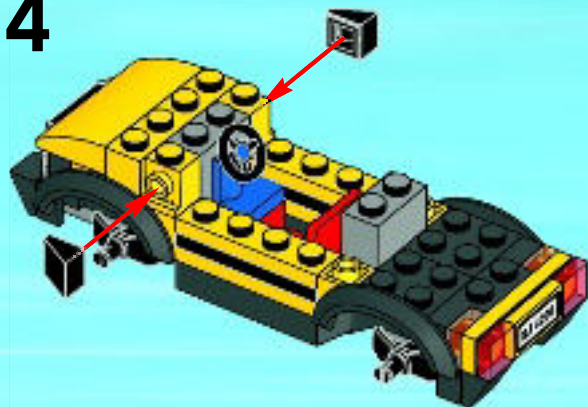

15

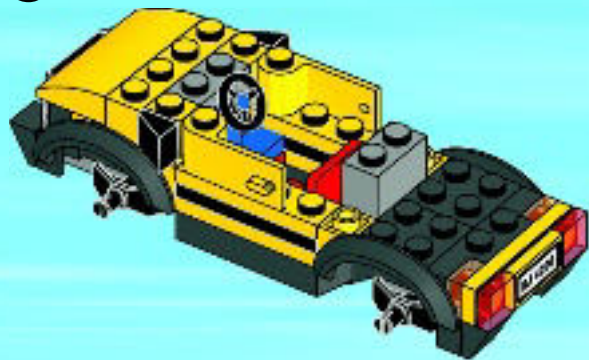

16

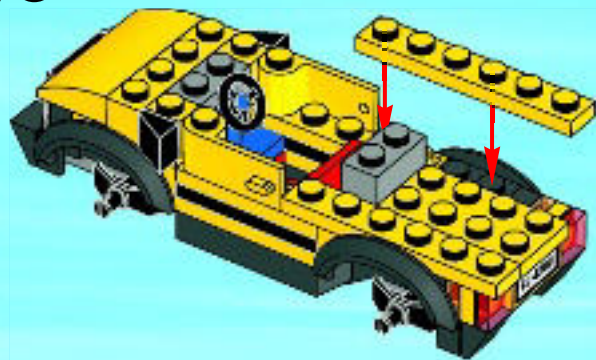

17

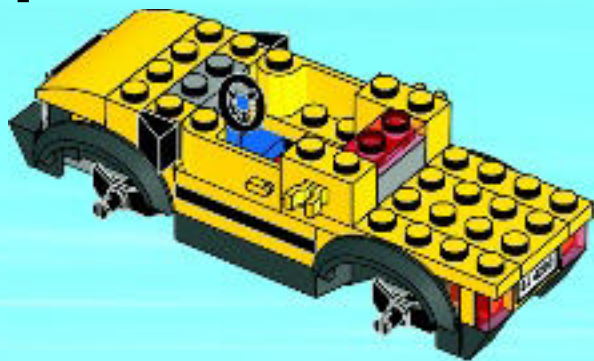

18



19

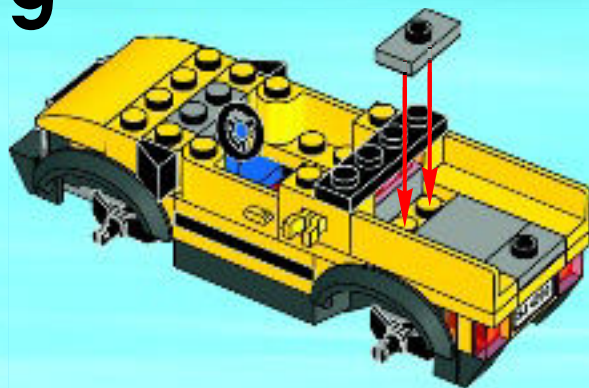

20

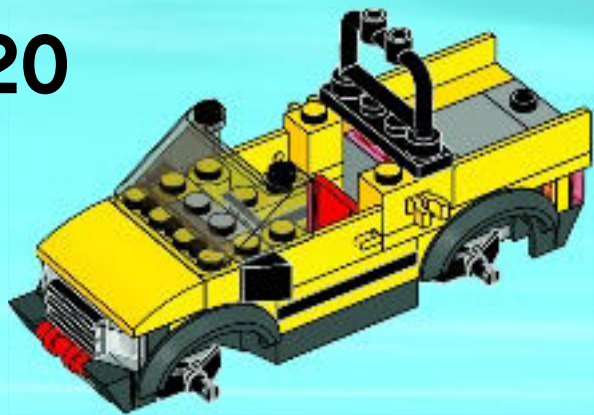

21



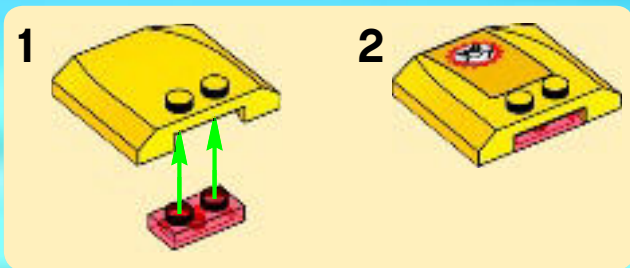

22

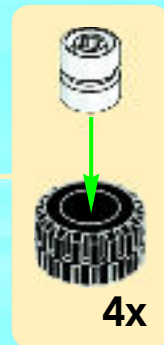
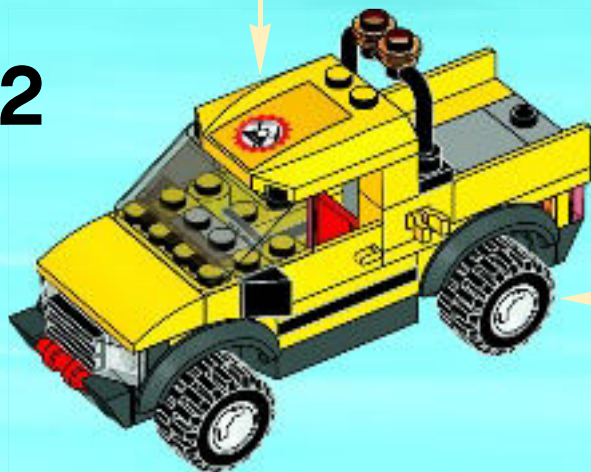

23

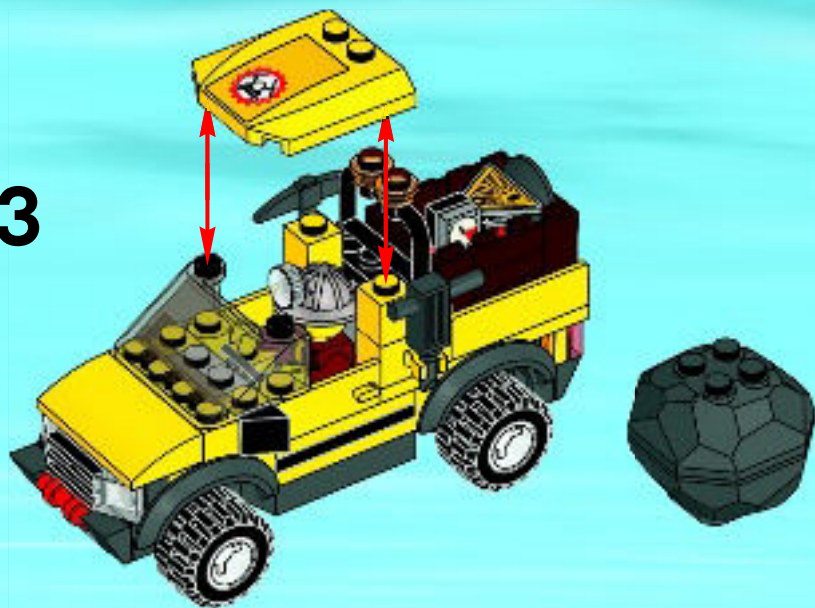



CITY



4204



4203



4202



4201



4200



www.LEGOclub.com/Max

LEGO club™

FREE*! GRATIS! GRATUIT!

*Paid subscription in Australia and New Zealand.
*Abonnement payant en Australie et Nouvelle-Zélande.

©2012 The LEGO Group.



Customer Service

Kundenservice

Service Consommateurs

Servicio Al Consumidor

www.lego.com/service or dial



: 00800 5346 5555

: 1-800-422-5346



WIN!

Go to www.LEGOsurvey.com/product to fill out a survey for a chance to win a cool LEGO® Product.

No purchase necessary.

Open to all residents where not prohibited.



www.LEGOsurvey.com/product

GEWINNE!

Nimm an der Umfrage auf www.LEGOsurvey.com/product teil und hab die Chance ein cooles LEGO® Produkt zu gewinnen!

Die Teilnahme am Gewinnspiel führt zu keinerlei Kaufverpflichtungen. Teilnahme in allen nicht ausgeschlossenen Ländern möglich.

WIN!

Ga naar www.LEGOsurvey.com/product, vul een enquêteformulier in en maak kans op een cool LEGO® product.

Geen aankoopverplichting. Iedereen mag deelnemen, uitgezonderd ingezetenden van landen waar een enquêteverbod geldt.

GAGNE!

Visite www.LEGOsurvey.com/product pour répondre à un questionnaire et avoir une chance de gagner un produit LEGO® très cool!

Aucune obligation d'achat. Ouvert à tous les résidents des pays autorisés.

当てよう!

www.LEGOsurvey.com/product にアクセスして、アンケートにご記入ください。当選者にはレゴ®製品を差し上げます。

お買い上げの必要はありません。

禁止されていない限り、すべての皆様にご利用いただけます。



www.LEGO.com

6012604

LEGO and the LEGO logo are trademarks of the LEGO Group. ©2012 The LEGO Group.